

TAPS

ARREDARE IL BAGNO - FURNISH THE BATHROOM

Le serie - The mixers series

■ Serie Q Color	pag. 012	■ Serie Blue	pag. 190
■ Serie Dream	pag. 020	■ Serie Project	pag. 196
■ Serie Infinity	pag. 026	■ Serie Ten	pag. 206
■ Serie Class Line	pag. 036	■ Serie Giga	pag. 214
■ Serie Flash	pag. 046	■ Serie Giga Four	pag. 224
■ Serie Atmos	pag. 060	■ Serie Musa	pag. 232
■ Serie Qubika	pag. 070	■ Serie Kiss	pag. 242
■ Serie Qubika Thermo	pag. 074	■ Serie Remix	pag. 258
■ Serie Qubika Cascata	pag. 088	■ Serie 35	pag. 268
■ Serie Qubika Thermo Cascata	pag. 198	■ Serie 100	pag. 280
■ Serie SQ3	pag. 106	■ Serie Liberty	pag. 288
■ Serie Minimal	pag. 116	■ Serie 1000/2000	pag. 302
■ Serie Minimal Color	pag. 138	■ Tutto Cucina	pag. 314
■ Serie Minimal Thermo	pag. 148	All Kitchen	
■ Serie Jazz	pag. 160	■ Serie Sensor	pag. 344
■ Serie Eagle	pag. 172	■ Serie Tempor	pag. 360
■ Serie Thermo	pag. 182	■ Accessori per rubinetteria	pag. 364
■ Serie Futura	pag. 186	Accessories	



Q COLOR

Q-Color e' il progetto che, partendo dallo studio di forme cubiche con base la cartuccia minimale da 25 mm, sviluppa un miscelatore dal design totalmente squadrato ma molto d'impatto, in cui le proporzioni sono concepite per riproporsi e donare alla serie una grande armonia tra le parti.

L'inserimento della cartuccia Color Fountain risulta essere il valore aggiunto che caratterizza questa linea.

L'emanazione di acqua illuminata e colorata avviene tramite questo dispositivo, dotato di luci a led, che non necessita di batterie o collegamenti alla corrente in quanto autoalimentato da un sistema interno a turbina.

Il Color Fountain, oltre a contenere un elemento termosensibile che a seconda dei modelli e della programmazione riconosce e segnala tramite diverso colore la temperatura dell'acqua, ha la possibilità di essere scelto in quattro modelli: la versione arcobaleno, una emozionante gamma cromatica in continua rotazione, la versione che segnala i passaggi di temperatura tramite il cambiamento dei colori rosso, giallo verde e blu, la versione soft che propone al cambio della temperatura i colori azzurro, bianco LED e rosa, e la versione totalmente bianco LED. Il dispositivo Color Fountain è, per completezza di informazione, interamente prodotto in Italia da S.T.S.R., azienda storica milanese sinonimo di alta qualità.

Q-Color unisce all'alto design la magia della luce e del colore per creare atmosfere sorprendenti.

Q-Color is the project that, starting from the concept of cubic shapes based on 25 mm minimal cartridge, develops a fully squared design and a very elegant impact mixer; proportions are conceived to be carried over and to give to this line a great harmony between the parts.

The inclusion of the Color Fountain cartridge is the added value characterizing this Line.

The coloured and lighted water supply operates through this device, equipped with led lights, that does not require batteries or electrical connections as it is self powered by an internal turbine system.

Besides containing a heat-sensitive element that recognizes and reports the water temperature using different colours depending on the model and the programming, Color Fountain can be chosen in four models: the Rainbow version, an exciting range of colours in continuous rotation, the version that reports the temperature changes through the change of the red, yellow, green and blue colours, the soft version using the blue, pink and white LED colours and the totally white LED version. The Color Fountain device, for completeness of information, is entirely produced in Italy by S.T.S.R., historical company based in Milan, synonymous with high quality.

Q-Color combines the design with the magic of light and colour in order to create amazing atmospheres.





CARATTERISTICHE TECNICHE:

La serie è dotata di cartuccia a dischi ceramici, Ø 25 mm,

TECHNICAL CHARACTERISTICS:

The series is equipped with ceramic cartridge, Ø 25 mm,

CARATTERISTICHE TECNICHE:

La cartuccia Color è prodotta in Italia da S.T.S.R., certificata CE ed interamente a norma.

Tutte le parti elettriche ed elettroniche sono perfettamente isolate dall'acqua garantendo un perfetto funzionamento a lungo termine.

La cartuccia è dotata anche di filtro in entrata che permette alla turbina di lavorare isolata dalle impurità presenti nell'acqua ed alla cartuccia di essere pulita tipo un normale aeratore.

L'intensità della luce non dipende dalla pressione dell'acqua e la cartuccia Color si aziona a 2.5lt/min

TECHNICAL CHARACTERISTICS:

The Color cartridge is produced in Italy

All the electrical and electronical parts are perfectly isolated from water guaranteeing a long term perfect performance.

The cartridge is equipped with an inlet filter that prevent any dirt to get into the turbine, the cartidge can be cleaned likely a normal aerator.

The color intensity does not depend on water pressure and the colotherapy cartridge starts performing at 2.5lt/m.

Il prodotto è disponibile in quattro varianti denominate A, B, C, D, di seguito dettagliate. Per evidenziare la Vostra scelta, aggiungere la lettera corrispondente a fine codice articolo.

The product is available in four variants named A, B, C, D, that we detail here following. To highlight your selection please add the choosen letter at the end of the article number.

A



La luce emanata è solo bianca
The light emitted is white only

B





La luce emanata cambia colore al variare della temperatura





Azzurro: fino a 32°
Bianco : da 32° a 38°
Rosa: oltre 38°

The light emitted changes color with temperature

Light Blue : up to 32°
White: from 32° to 38°
Pink: from 38°



C







La luce emanata cambia colore al variare della temperatura

Blu : fino a 28°
Verde : da 28° a 33°
Giallo: da 33° a 38°
Rosso: da 38°

The light emitted changes color with temperature

Blue : up to 28°
Green: from 28° to 33°
Yellow: from 33° to 38°
Red: from 38°



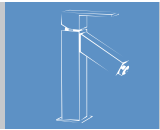

D



Un arcobaleno di colori e sfumature si alternano creando un continuo gioco emozionale

A rainbow of colors and shades alternate, creating a constant emotional game



QR 20

Miscelatore bidet con scarico.
Bidet mixer with pop-up waste.



QR 10

Miscelatore lavabo con luce led e scarico.
Washbasin mixer with led light and pop-up waste.



QR 10L

Miscelatore lavabo alto con luce led e scarico click clack, con troppo pieno.
High Washbasin mixer with led light and click-clack waste, with overflow.

QR 21

Miscelatore bidet senza scarico.
Bidet mixer without pop-up waste.

QR 11

Miscelatore lavabo con luce led, senza scarico.
Washbasin mixer with led light, without pop-up waste.

QR 11L

Miscelatore lavabo alto con luce led, senza scarico.
High Washbasin mixer with led light without waste.





QR 10L XL

Miscelatore lavabo alto, altezza 36,5 cm da base a bocca, interasse 11 cm, con luce led e scarico click clack, con troppo pieno.
High Washbasin mixer, high 36,5 cm from bottom to the spout, interaxis 11 cm, with led light, and click-clack waste, with overflow.

QR 11L XL

Miscelatore lavabo alto, altezza 36,5 cm da base a bocca, interasse 11 cm, con luce led, senza scarico.
High Washbasin mixer, high 36,5 cm from bottom to the spout, interaxis 11 cm, with led light without waste.

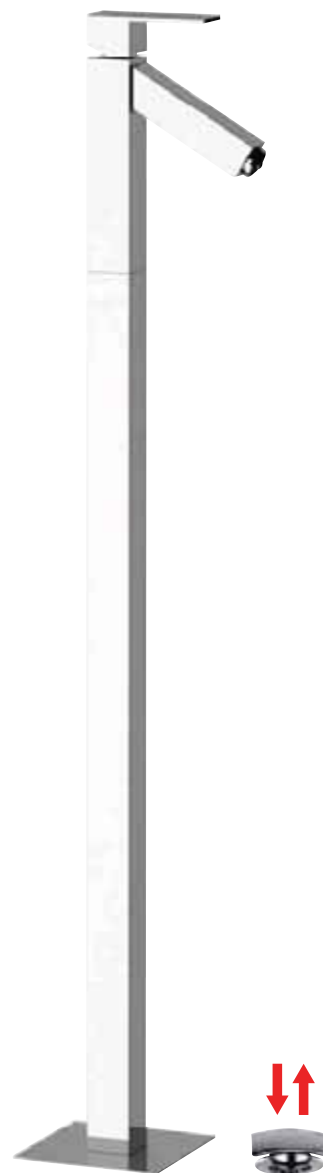

QR 18

Miscelatore monocomando lavabo da pavimento, altezza bocca cm 95, con luce led e scarico click-clack.
Single-lever mixer floor mounting, spout height cm 95 with led light, click-clack waste.



S 30 3

Miscelatore doccia incasso.
Built-in shower mixer.



91 QR

Bocca incasso con luce led.
Built-in spout with led light.



S 09 3

Miscelatore doccia incasso con deviatore.
Built-in bath/shower mixer with diverter.



QR 39

Miscelatore doccia esterno con kit doccia.
Exposed shower mixer with shower kit.

QR 31

Miscelatore doccia esterno.
Exposed shower mixer.



QR 02

Miscelatore vasca esterno con luce led, flessibile cm 150 e doccia duplex.

Exposed bath/shower mixer with led light, flexible cm 150 and duplex shower.

QR 05

Miscelatore vasca esterno con luce led, senza kit doccia.
Exposed bath/shower mixer with led light, without shower.

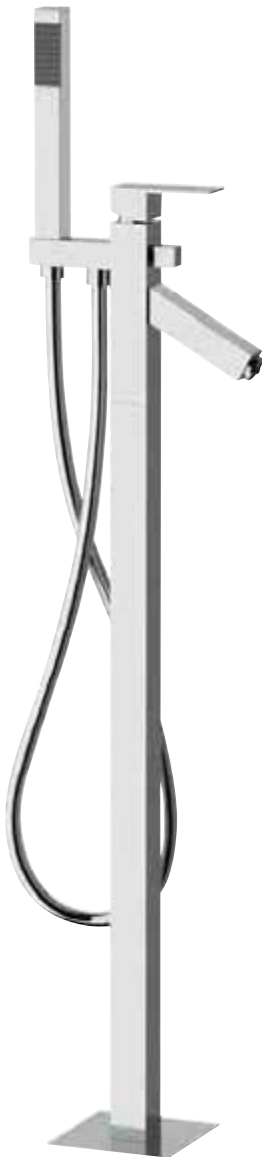

QR 08

Miscelatore vasca da pavimento con luce led, altezza bocca cm 85, con deviatore e kit.

Free standing bath mixer with led light, spout height cm 85, with diverter and shower kit.



QR 07

Miscelatore monocomando bordo vasca con deviatore, bocca con luce led e doccetta in ottone cromato.

Single-lever deck bath/shower mixer with diverter, led light spout and c.p. brass handshower.

Q COLOR

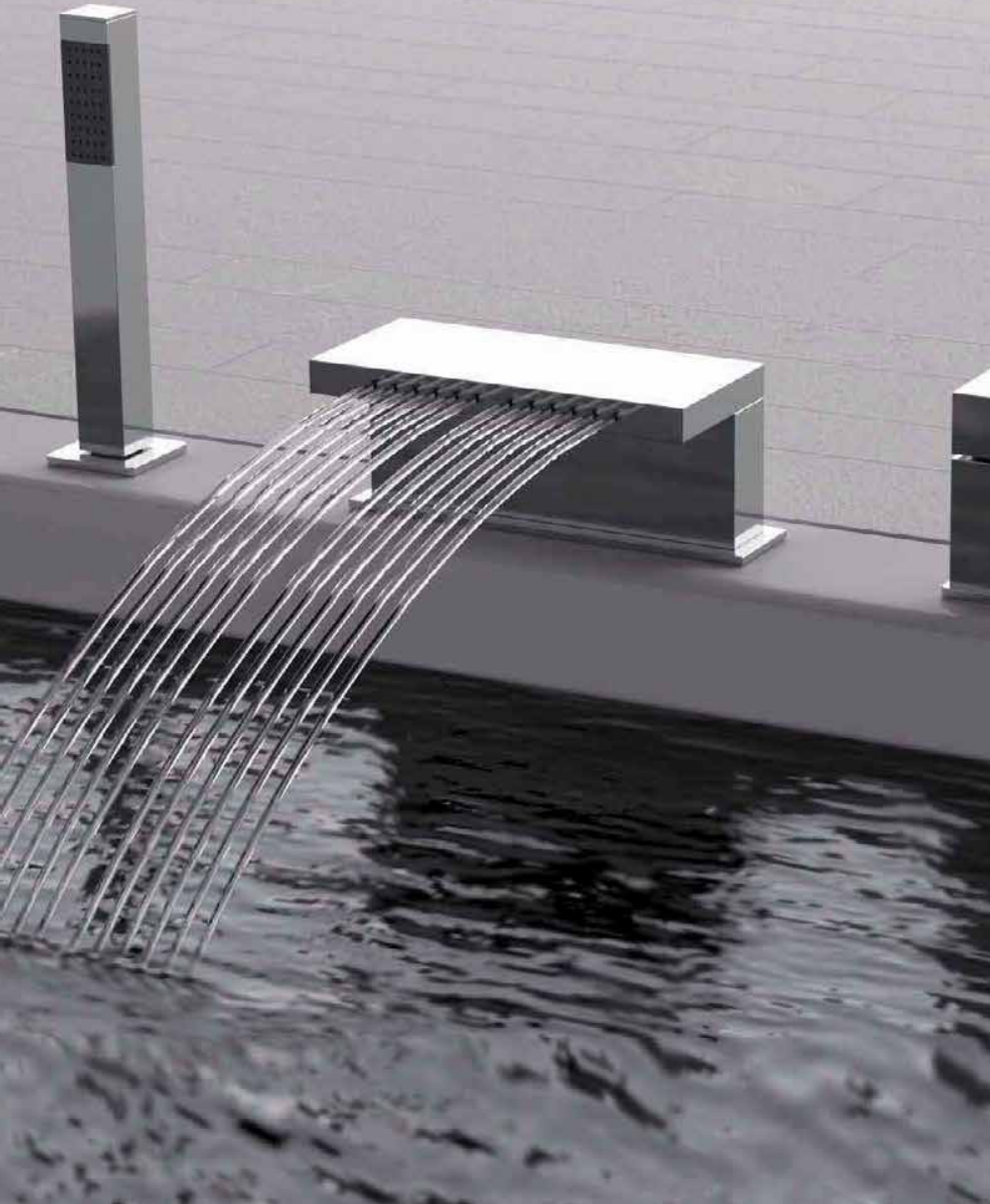

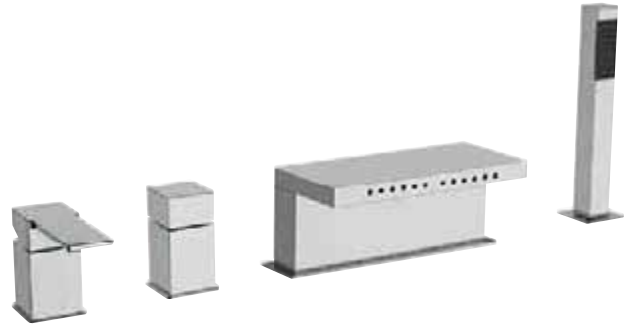

Q 06

Miscelatore monocomando bordo vasca con deviatore, bocca con effetto multigetto e doccetta in ottone cromato.

Single lever deck bath/shower mixer with diverter, spout with multijets effect and c.p. brass hand shower.



QC 06

Miscelatore monocomando bordo vasca con deviatore, bocca cascata e doccetta in ottone cromato

single lever deck bath/shower mixer with diverter, waterfall spout and c.p. brass hand shower



DREAM

Dream è l'espressione di un design chiaro e pulito, attento ai dettagli che fanno la differenza tra un prodotto normale ed uno di successo.

Gli amanti dei particolari noteranno sicuramente che il corpo è sviluppato da una forma ellittica che sale verso l'alto con uno sforno esterno; in questo modo abbiamo eliminato esteticamente il raggio di giunzione tra corpo e bocca. Quest'ultima è estremamente sottile e rastremata verso l'aeratore invisibile. La basetta ultra piatta di 2 mm è un particolare dal carattere moderno e hi-tech. L'insieme di questi fattori donano eleganza e armoniosità al prodotto.

Dream in sostanza è un sogno, il sogno di avere una rubinetteria dal design raffinato ad un costo ragionevole.

Dream is the expression of a clear and clean design, attentive to the details that make the difference between a normal product and a successful one.

Details lovers can definitely notice that the body is developed on an elliptically shape going upward with an external mould shape, thus aesthetically removing the junction radius between body and spout. The spout is extremely thin and tapered towards the invisible aerator. The ultra flat 2 mm base is a modern and hi-tech feature. All of these factors give elegance and harmony to the product.

Dream is essentially a dream, the dream to have refined design faucets at a reasonable price.



CARATTERISTICHE TECNICHE:

La serie è dotata di cartuccia a dischi ceramici, Ø 35 mm, prodotta da S.T.S.R. - Studio Tecnico Sviluppo e Ricerche - www.stsr.it

TECHNICAL CHARACTERISTICS:

The series is equipped with ceramic cartridge, Ø 35 mm, produced by S.T.S.R. - Research Development Technical Office - www.stsr.it



D 10

Monocomando lavabo con scarico.
Single-lever basin mixer with pop-up waste.

D 11

Monocomando lavabo, senza scarico.
Single-lever basin mixer without pop-up waste.



D 10 L

Monocomando lavabo alto: altezza 254 mm, interasse 167 mm con click-clack.

High basin mixer 254 mm, spacing 167 mm with click-clack waste.

D 11 L

Monocomando lavabo alto: altezza 254 mm, senza scarico.
High basin mixer 254 mm, without pop-up waste.



D 20

Monocomando bidet con scarico.
Single-lever bidet mixer with pop-up waste.

D 21

Monocomando bidet, senza scarico.
Single-lever bidet mixer without pop-up waste.



D 60

Miscelatore incasso per shut-off comprensivo di: doccetta shut-off art. 3320L, supporto doccia-presa acqua su piastra in ottone cromato e flessibile doccia cm 120.

Built-in shower mixer set including: shut-off art. 3320L, shower holder water punch on flange all in c.p. brass and shower flexible cm 120.



D 38

Miscelatore doccia esterno con kit doccia.
Exposed shower mixer with shower kit.



D 33

Miscelatore doccia esterno senza kit doccia.
Exposed shower mixer without shower kit.



D 30

Monocomando doccia incasso con piastra in lastra di ottone cromato.
Built-in shower mixer with flange in c.p. brass cut sheet.



D 09

Monocomando vasca/doccia incasso con deviatore e con piastra in lastra di ottone cromato.
Built-in bath/shower mixer with diverter and with flange in c.p. brass cut sheet.

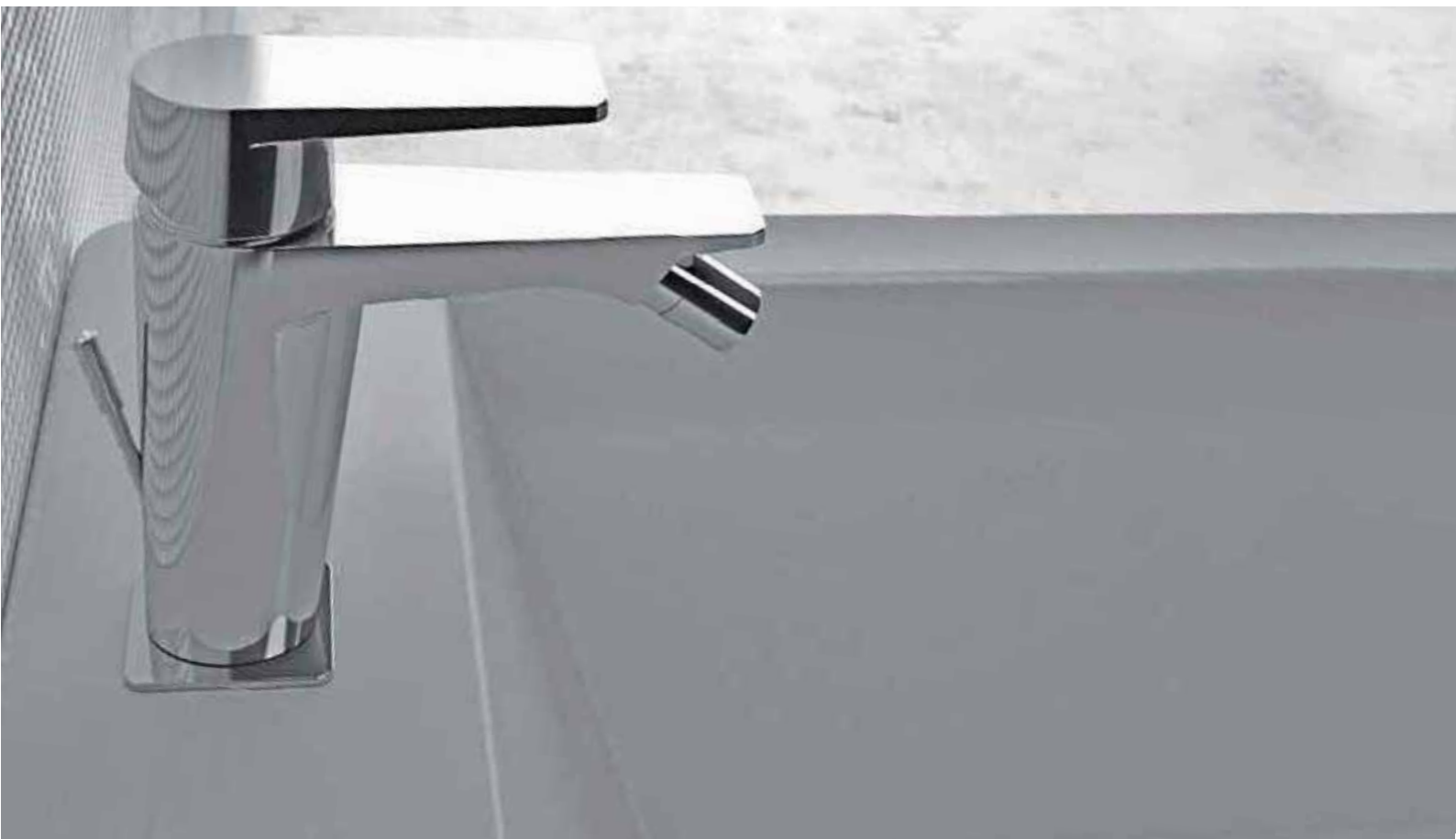

DREAM



D 05

Miscelatore vasca esterno senza set doccia.
Exposed bath/shower mixer without shower kit.

D 02

Miscelatore vasca esterno con flessibile cm 150 e doccia.
Exposed bath/shower mixer with flexible cm 150 and shower.



D 07

Miscelatore monocomando bordo vasca con deviatore a leva, bocca minimale e doccetta in ABS cromato a due posizioni.
Single lever deck bath mixer with lever diverter, with minimal spout and 2 positions chrome plated ABS hand shower.



D 06

Miscelatore monocomando bordo vasca con deviatore, bocca con effetto multigetto e doccetta in ottone cromato.
Single lever deck bath/shower mixer with diverter, spout with multijets effect and c.p. brass hand shower.





KITCHEN



D 72

Miscelatore monocomando monoforo 90°, con canna alta a "U" girevole.
Single-lever sink mixer 90°, high movable "U" spout.



D 72 C

Miscelatore monocomando per lavello, con bocca alta girevole, modello corto, tipo lusso.
Single-lever one-hole sink mixer, with short movable spout, luxury type.



D 42 R

Miscelatore monocomando monoforo 90°, con canna alta a girevole.
Single-lever sink mixer 90°, high movable spout.







INFINITY

La serie di miscelatori monocomando Infinity nasce da un'idea di design in cui la resa estetica di leggerezza del prodotto ricopre un ruolo di primaria importanza.

La morbidezza del corpo ed i suoi raggi addolciti sono interrotti in corrispondenza della bocca di erogazione e della leva, entrambe caratterizzate dallo stesso profilo, estremamente assottigliate e con una superficie superiore completamente piana.

Questo design dona alla serie un grande slancio ed ogni singolo prodotto visto nella sua globalità comunica grande personalità ed è autentica espressione di moderna eleganza.

The single lever mixer line Infinity has born from an idea of design in which a role of primary importance is given to the final impact of lightness that the whole line gives. The smoothness of the body and its wide rays are interrupted in correspondance of the spout and the lever which suddenly show a completely flat upper surface.

The lever and the spout share the same profile extremely slim giving the line a great enhance. Every single product, seen in its globality, communicate great personality and it's an authentic expression of modern elegance.



CARATTERISTICHE TECNICHE:

La serie è dotata di cartuccia a dischi ceramici, Ø 35 mm, prodotta da S.T.S.R. - Studio Tecnico Sviluppo e Ricerche - www.stsr.it

TECHNICAL CHARACTERISTICS:

The series is equipped with ceramic cartridge, Ø 35 mm, produced by S.T.S.R. - Research Development Technical Office - www.stsr.it



I 10

Monocomando lavabo con scarico.
Single-lever basin mixer with pop-up waste.

I 11

Monocomando lavabo, senza scarico.
Single-lever basin mixer without pop-up waste.



I 10 L

Monocomando lavabo alto con click-clack.
High basin mixer with click-clack waste.

I 11 L

Monocomando lavabo alt, senza scarico.
High basin mixer, without pop-up waste.



I 15

Miscelatore monocomando a incasso per lavabo, con piastra in ottone cromato e bocca lunghezza 18 cm.
Single-lever built-in basin mixer, with wall flange in chrome plated brass and spout length 18 cm.



I 20

Monocomando bidet con scarico.
Single-lever bidet mixer with pop-up waste.

I 21

Monocomando bidet, senza scarico.
Single-lever bidet mixer without pop-up waste.







I 60

Miscelatore incasso per shut-off comprensivo di: doccetta shut-off art. 3320L, supporto doccia-presa acqua su piastra in ottone cromato e flessibile doccia cm 120.

Built-in shower mixer set including: shut-off art. 3320L, shower holder water punch on flange all in c.p. brass and shower flexible cm 120.



IC31 REL

Miscelatore monocomando esterno doccia, interasse 100 mm e kit composto da doccia a pulsante art. 3320L, flessibile conico 120 cm e supporto art. 33950 in ottone cromato.

Wall mounted single lever shower mixer, interaxis 100 with shut-off handshower art. 3320L, conical flexible hose cm 120 and shower holder art. 33950.

IC31

Miscelatore monocomando esterno doccia, interasse 100 mm, senza kit doccia.

Wall mounted single lever shower mixer, interaxis 100, without dhower set.



I 46

Miscelatore lavabo/vasca con canna fusa lunga 30 cm e deviatore senza kit doccia.

Wall basin/bath single lever mixer with cm 30 long casted spout with diverter and without duplex shower.



I 49

Miscelatore lavabo/vasca con canna fusa lunga 30 cm e deviatore con kit doccia.

Wall basin/bath single lever mixer with cm 30 long casted spout with diverter and with duplex shower.

INFINITY



I 02

Miscelatore vasca esterno con flessibile cm 150 e doccetta con getti in silicone anticalcare ovale.

Wall mounted bath mixer with flexible cm 150 and anti-limestone oval handshower with silicon jets.

I 05

Miscelatore vasca esterno senza kit doccia.

Wall mounted bath/shower mixer without shower kit.



I 07

Miscelatore monocomando bordo vasca con deviatore a leva, bocca minimale e doccetta anticalcare.

Single lever deck bath mixer with lever diverter, with minimal spout and anti-limestone hand shower.



I 06

Miscelatore monocomando bordo vasca con deviatore, bocca con effetto multigetto e doccetta in ottone cromato.

Single lever deck bath/shower mixer with diverter, spout with multijets effect and c.p. brass hand shower.





I 39
 Miscelatore doccia esterno con kit doccia.
 Exposed shower mixer with shower kit.

I 31
 Miscelatore doccia esterno senza kit doccia.
 Exposed shower mixer without shower kit.



I 38
 Miscelatore doccia esterno con leva frontale e kit doccia.
 Wall mounted shower mixer with frontal lever and shower kit.

I 33
 Miscelatore doccia esterno con leva frontale, senza kit doccia.
 Wall mounted shower mixer with frontal lever, without shower kit.



I 30
 Monocomando doccia incasso con piastra in lastra di ottone cromato.
 Built-in shower mixer with flange in c.p. brass cut sheet.



I 09
 Monocomando vasca/doccia incasso con deviatore e con piastra in lastra di ottone cromato.
 Built-in bath/shower mixer with diverter and with flange in c.p. brass cut sheet.



317V 317RV
 Saliscendi cromato con asta minimale ovale dritta e doccetta con getti in silicone anticalcare ovale.
 C.p. sliding rail set with minimal oval rod and anti-limestone oval handshower with silicon jets.



I09 S01

Set doccia composto da:

Art. 348S 354QI: soffione doccia cm 20x20 quadrato con angoli arrotondati ultrapiatto in abs cromato, e getti anticalcare con braccio quadrato in ottone cm 30.

Art. I09: Monocomando vasca/doccia incasso con deviatore.

Art. 317V 317RV 333CN 150: saliscendi cromato con asta minimale ovale dritta, doccetta anticalcare e flessibile conico in ottone cromato cm 150.

Art. 309S: presa acqua quadrata in ottone cromato.

Shower set composed of:

Art. 348S 354QI: Chrome plated abs showerhead, squared with rounded edges, ultraflat, silicon selfcleaning antilimestone jets, with squared arm in brass cm 30.

Art. I09: Built-in bath/shower mixer with diverter.

Art. 317V 317RV 333CN 150: c.p. sliding rail set with minimal oval rod and autocleaning antilimestone handshover and conical shower flexible in c.p. brass cm 150.

Art. 309S: lux water punch squared type.



I09 S02

Set doccia composto da:

Art. 348S 354QI: soffione doccia cm 20x20 quadrato con angoli arrotondati ultrapiatto in abs cromato, e getti anticalcare con braccio quadrato in ottone cm 30.

Art. I09: Monocomando vasca/doccia incasso con deviatore.

Art. 339S0S: supporto fisso quadrato in ottone cromato per flessibile con attacco conico.

Art. 317RV 333CN 150: doccetta cromata minimale ovale anticalcare con flessibile conico in ottone cromato cm 150.

Art. 309S: presa acqua quadrata in ottone cromato.

Shower set composed of:

Art. 348S 354QI: Chrome plated abs showerhead, squared with rounded edges, ultraflat, silicon selfcleaning antilimestone jets, with squared arm in brass cm 30.

Art. I09: Built-in bath/shower mixer with diverter.

Art. 339S0S: squared shower holder in c.p. brass, for conical nut flexible.

Art. 317RV 333CN 150: c.p. minimal oval handshower antilimestone with shower flexible hose in brass cm 150.

Art. 309S: lux water punch squared type.



KITCHEN



I 41

Miscelatore monocomando per lavello a muro, con bocca girevole.
Single-lever wall mounted sink mixer, with movable spout.



I 41 S

Miscelatore monocomando per lavello a muro, con bocca a "S" girevole.
Single-lever wall mounted sink mixer, with "S" movable spout.



I 72

Miscelatore monocomando monoforo 90°, con canna alta a "U" girevole.
Single-lever sink mixer 90°, high movable "U" spout.



I 72 C

Miscelatore monocomando per lavello, con bocca alta girevole, modello corto, tipo lusso.
Single-lever one-hole sink mixer, with short movable spout, luxury type.



I 42 R

Miscelatore monocomando per lavello, con bocca alta girevole, tipo lusso.
Single-lever one-hole sink mixer, with high movable spout, luxury type.



CLASS LINE

Class line è una serie di miscelatori ideata per arredare tutti gli spazi bagno in cui l'interesse della clientela punta ad una linea dal design moderno mantenendo tutti i confort e dei miscelatori di tipo classico.

Il design della serie gioca sul parallelismo tra leva e bocca di erogazione rendendo le superfici completamente piatte e riflettenti per poi fonderle con raggiature più morbide, in una perfetta unione tra tondo e quadro.

La serie è dotata di molti elementi che ne qualificano la gamma per ampiezza di scelta.

Le tre tipologie di lavabo, standard, alto e a colonna, l'uso del brevetto per la protezione dell'aeratore bidet, l'elegante incasso lavabo e le linee molto ricercate del gruppo vasca e dell'esterno doccia, fanno di Class Line una serie completa che mette in evidenza caratteristiche tecniche e di design esemplari rimanendo comunque in una gamma molto competitiva.

Class line is a series of mixers designed in order to furnish all the bathroom spaces in which the interests of customers target to a modern design line also able to keep all of the comforts of the classic mixers. The design of the series plays on parallelism between the lever and the outlet spout, making the surfaces completely flat, reflective and then joining them with softer radius, in a perfect matching between round and squared.

The line is equipped with many elements that qualify the range for its wide choice.

The three types of basins, standard, high and column, the use of the patent for the protection of the bidet aerator, the elegant built-in basin and the very researched bath-tube and the external shower mixer, make Class Line a complete set of faucets that highlights technical and design features remaining in a very competitive range.





CARATTERISTICHE TECNICHE:

La serie è dotata di cartuccia a dischi ceramici, Ø 35 mm, prodotta da S.T.S.R. - Studio Tecnico Sviluppo e Ricerche - www.stsr.it

TECHNICAL CHARACTERISTICS:

The series is equipped with ceramic cartridge, Ø 35 mm, produced by S.T.S.R. - Research Development Technical Office - www.stsr.it



L 10

Monocomando lavabo con scarico.
Single-lever basin mixer with pop-up waste.



interaxis 130 mm

L 10 L

Monocomando lavabo alto: altezza 113 mm, interasse 130 mm, con scarico.
High basin mixer 110 mm, interaxis 130 mm, with pop-up waste.



interaxis 180 mm

L 10 LXL

Monocomando lavabo alto: altezza 250 mm, interasse 180 mm, con click-clack.
High basin mixer 250 mm, interaxis 180 mm, with click-clack.

L 11

Monocomando lavabo, senza scarico.
Single-lever basin mixer without pop-up waste.

L 11 L

Monocomando lavabo alto: altezza 113 mm, interasse 130 mm, senza scarico.
High basin mixer 110 mm, interaxis 130 mm, without pop-up waste.

L 11 LXL

Monocomando lavabo alto: altezza 250 mm, interasse 180 mm, senza scarico.
High basin mixer 250 mm, interaxis 180 mm, without pop-up waste.

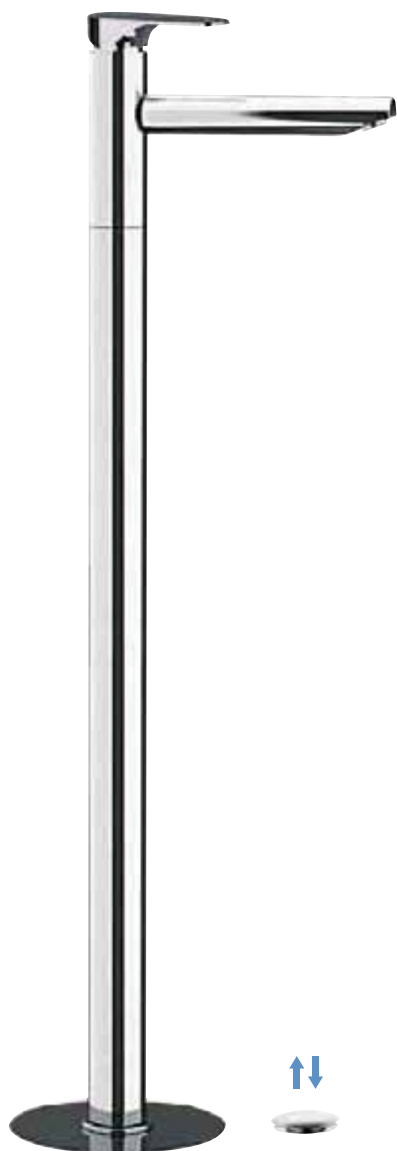

L 18

Miscelatore monocomando lavabo da terra, altezza bocca cm 95, con scarico click-clack con troppo pieno.
Single-lever mixer for floor mounting, spout height cm 95, with clickclack waste with overflow.



L 63

Miscelatore incasso per shut-off.
Built-in shut-off mixer.



L 15

Miscelatore monocomando a incasso per lavabo, con piastra rettangolare in ottone cromato e bocca lunghezza 18 cm.
Single-lever built-in basin mixer, with rectangular wall flange in chrome plated brass and spout length 18 cm.



PATENTED

L 20

Monocomando bidet con scarico.
Single-lever bidet mixer with pop-up waste.

L 21

Monocomando bidet, senza scarico.
Single-lever bidet mixer without pop-up waste.



L 60

Miscelatore incasso per shut-off comprensivo di: doccetta shut-off art. 3320L, supporto doccia-presa acqua su piastra in ottone cromato e flessibile doccia cm 120.
Built-in shower mixer set including; shut-off art. 3320L, shower holder-water punch on flange, all in c.p. brass and shower flexible cm 120.



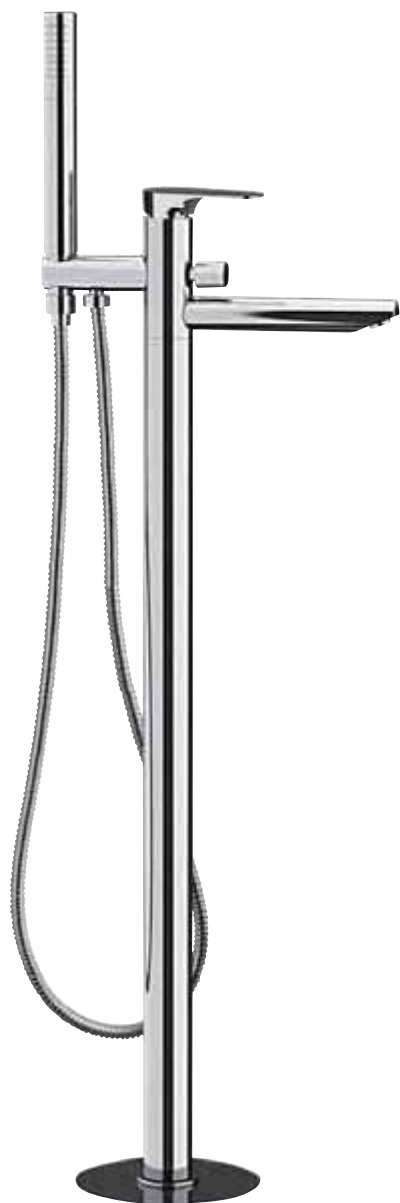

L 08

Miscelatore bordo vasca da pavimento, altezza bocca cm 85, con deviatore e kit doccia.

Single-lever bath mixer floor mounting, spout height cm 85, with diverter and shower kit.



L 02

Miscelatore vasca esterno con flessibile cm 150 e doccia duplex.

Exposed bath/shower mixer with flexible cm 150 and duplex shower.

L 05

Miscelatore vasca esterno senza set doccia.

Exposed bath/shower mixer without shower set.



L 07

Miscelatore monocomando bordo vasca con deviatore a molla, bocca minimale e doccetta minimale in ottone cromato.

Single lever deck bath mixer with spring diverter, with minimal spout and minimal chrome plated brass hand shower.



L 06

Miscelatore monocomando bordo vasca con deviatore, bocca con effetto multigetto e doccetta in ottone cromato.

Single lever deck bath/shower mixer with diverter, spout with multijets effect and c.p. brass hand shower.

CLASS LINE



L 30 L

Monocomando doccia incasso con piastra lusso Class Line.
Built-in shower mixer with deluxe Class Line plate.



L 09 L

Monocomando vasca/doccia incasso con deviatore con piastra lusso Class Line.
Built-in bath/shower mixer with diverter with deluxe Class Line Plate.



L 30

Monocomando doccia incasso.
Built-in shower mixer.



L 09

Monocomando vasca/doccia incasso con deviatore.
Built-in bath/shower mixer with diverter.



317M 319MO

Saliscendi minimale con doccetta con getti in silicone anticalcare, idromassaggio minimale a 2 funzioni.
Minimal sliding rail set with anti-limestone, hydromassage minimal 2 function handshower with silicon jets.



L 39

Miscelatore doccia esterno con kit doccia.
Exposed shower mixer with shower kit.

L 31

Miscelatore doccia esterno senza kit doccia.
Exposed shower mixer without shower kit.



L 49

Miscelatore lavabo/vasca con canna fusa lunga 30 cm e deviatore con kit doccia.
Wall basin/bath single lever mixer with cm 30 long casted spout with diverter and with duplex shower.

L 46

Miscelatore lavabo/vasca con canna fusa lunga 30 cm e deviatore senza kit doccia.
Wall basin/bath single lever mixer with cm 30 long casted spout with diverter and without duplex shower.



WELLNESS



L 09 S 02

Set doccia composto da:
 Art. 356MD 20 348N 30 soffione minimale in abs lusso Ø 20 cromato con braccio in ottone cm 30.
 Art. L 09 L Monocomando vasca/doccia incasso con deviatore, piastra lusso Class Line.
 Art. 319MO 337M doccia duplex anticalcare con supporto presa acqua in ottone cromato e flessibile conico cm 150.

Shower set composed of:
 Art. 356MD 20 348N 30 Chrome plated minimal deluxe abs shower head Ø 20, with c.p. brass minimal shower arm cm 30.
 Art. L 09 L Built-in bath/shower mixer with diverter with deluxeClass Line Plate.
 Art. 319MO 337M anti-limestone handshower with waterpunch-shower holder in c.p. brass and conical flexible cm 150.

L 09 S 01

Set doccia composto da:
 Art. 356MD 20 348N 30 soffione minimale in abs lusso Ø 20 cromato con braccio in ottone cm 30.
 Art. L 09 L Monocomando vasca/doccia incasso con deviatore con piastra lusso Class Line.
 Art. 317M 319MO saliscendi minimale con doccetta anticalcare.
 Art. 309 L presa acqua pesante e flessibile doccia cm 150.

Shower set composed of:
 Art. 356MD 20 348N 30 C.p. minimal deluxe abs shower head Ø 20, with c.p. brass shower arm minimal cm 30.
 Art. L 09 L Built-in bath/shower mixer with diverter with deluxe Class Line Plate.
 Art. 317 M 319MO Minimal sliding rail set with anti-limestone handshower and shower flexible cm 150.
 Art. 309 L c.p. brass water punch, heavy type.

CLASS LINE



L 41

Miscelatore monocomando per lavello a muro, con bocca girevole.
Single-lever wall mounted sink mixer, with movable spout.



L 41 S

Miscelatore monocomando per lavello a muro, con bocca a "S" girevole.
Single-lever wall mounted sink mixer, with "S" movable spout.



L 42

Miscelatore monocomando per lavello, con bocca alta girevole, tipo lusso.
Single-lever one-hole sink mixer, with high movable spout, luxury type.



L 42 C

Miscelatore monocomando per lavello, con bocca alta girevole, modello corto, tipo lusso.
Single-lever one-hole sink mixer, with high movable spout, shorter model, luxury type.



L 40

Miscelatore monocomando per lavello, con bocca girevole.
Single-lever one-hole sink mixer, with movable spout.



KITCHEN



L 42 U

Miscelatore monocomando per lavello, con bocca alta a "U" girevole.

Single-lever sink mixer, with high "U" movable spout.



L 72

Miscelatore monocomando monoforo 90°, con canna alta a "U" girevole.

Single-lever sink mixer 90°, high movable "U" spout.



L 72 C

Miscelatore monocomando per lavello, con bocca alta girevole, modello corto, tipo lusso.

Single-lever one-hole sink mixer, with short movable spout, luxury type.



L 42 R

Miscelatore monocomando per lavello, con bocca alta girevole, tipo lusso.

Single-lever one-hole sink mixer, with high movable spout, luxury type.



FLASH

Come la forma del lampo, il suo profilo si presenta deciso e inconfondibile. Come il bagliore del lampo, la sua tecnica costruttiva brilla di luce propria. Come la forza del lampo, il suo impatto visivo è assolutamente unico. La serie di miscelatori "flash" è il punto d'arrivo di uno studio accurato che ha saputo coniugare bellezza estetica, elevata metodologia progettuale e forte impatto emozionale.

Gli elementi assemblati perfettamente come una scultura moderna, l'aeratore incassato nel corpo che esalta la tecnicità del modello, l'acqua che scorre liberamente creando un effetto cascata molto suggestivo, le dimensioni contenute grazie alla cartuccia diametro 25 e non ultimo il design essenziale e rigoroso, sono tutti elementi che conferiscono alla serie un'immagine avveniristica di sicuro successo.

Like the shape of the flash, its profile is strong and unmistakable. Like the light of the flash, its construction technique shines its light. Like the strength of the flash, its visual impact is definitely unique.

The series of mixers "flash" is the culmination of a careful study that has managed to combine aesthetic beauty, high design methodology and strong emotional impact. The elements perfectly combined as a modern sculpture, the aerator embedded in the body that enhances the technical nature of the model, the water flowing freely creating a very suggestive waterfall effect, the limited size thanks to the 25 mm cartridge diameter and, not least, the essential and rigorous design are all elements that give a futuristic image of sure success to the series.

FLASH



CARATTERISTICHE TECNICHE:

La serie è dotata di cartuccia a dischi ceramici, Ø 25 mm, prodotta da S.T.S.R. - Studio Tecnico Sviluppo e Ricerche - www.stsr.it

TECHNICAL CHARACTERISTICS:

The series is equipped with ceramic cartridge, Ø 25 mm, produced by S.T.S.R. - Research Development Technical Office - www.stsr.it



Modello senza cascata con aeratore rettangolare inserito a filo del corpo superiore. Flusso d'acqua regolare e ben definito che fluisce direttamente nel lavello.

Model without waterfall but with rectangular aerator inserted in line with the mixer body. Regular water flow and well defined, it flows directly in the sink.



Modello con cascata e aeratore rettangolare incassato all'interno del corpo superiore. Flusso regolare e ben definito con scivolo d'acqua visivo.

Model with waterfall and rectangular aerator built in the mixer body. Regular and well defined flow, with waterfall show effect.



Z 10

Miscelatore monocomando per lavabo, con scarico.
Single-lever basin mixer with pop-up waste.

Z 11

Miscelatore monocomando per lavabo, senza scarico.
Single-lever basin mixer without pop-up waste.



ZC 10

Miscelatore monocomando per lavabo, con bocca cascata e scarico.
Single-lever basin mixer with waterfall spout and pop-up waste.

ZC 11

Miscelatore monocomando per lavabo, con bocca cascata, senza scarico.
Single-lever basin mixer with waterfall spout, without pop-up waste.



ZC 10 L

Miscelatore monocomando alto per lavabo, con bocca a cascata e scarico click-clack con troppo pieno.

Single-lever basin mixer high neck with waterfall spout and click-clack waste with overflow.

ZC 10 LB

Come art. ZC 10 L, con scarico click-clack senza troppo pieno.

As art. ZC 10 L, with click-clack waste without overflow.

ZC 11 L

Come art. ZC 10 L, senza scarico.

As art. ZC 10 L, without click-clack waste.



Z 18

Miscelatore lavabo da pavimento, altezza bocca cm 95, scarico click-clack con troppo pieno.

Single-lever basin mixer floor mounting, spout height cm 95, click-clack waste with overflow.







Z 20

Miscelatore monocomando per bidet, con aeratore direzionabile e con scarico.

Single-lever bidet mixer with adjustable aerator and with pop-up waste.

Z 21

Miscelatore monocomando per bidet, con aeratore direzionabile, senza scarico.

Single-lever bidet mixer with adjustable aerator, without pop-up waste.



Z 60

Miscelatore incasso per shut-off comprensivo di: doccetta shut-off art 3320S, supporto doccia- presa acqua su piastra in ottone cromato e flessibile doccia cm 120.

Built-in shut-off mixer set including : shut.off art 3320S, shower holder-water punch on flange, all in c.p. brass and shower flexible cm 120.



Z 63

Miscelatore incasso per shut-off.

Built-in shut-off mixer.



Nel miscelatore per bidet l'aeratore è parzialmente inserito nel corpo superiore in modo tale da nascondere la parte dello snodo ma allo stesso tempo garantire un perfetto movimento rotazionale.

In the bidet mixer the aerator is partially built in the body in order to hide the joint part but in the meantime to guarantee a perfect rotational movement.



Il pomolo salterello ricalca le stesse forme del profilo del miscelatore e della leva unite in un solo piccolo particolare.

The pop-up knot shape reproduce the shape of both the mixer and the handle together into a little important detail.









ZC 02

Miscelatore monocomando per vasca, esterno, con bocca a cascata e con set doccia.

Single-lever external bath mixer, with waterfall spout and shower set.

ZC 05

Miscelatore monocomando per vasca, esterno, con bocca a cascata, senza set doccia.

Single-lever external bath mixer, with waterfall spout, without shower set.



Z 07

Miscelatore monocomando bordo vasca serie Flash con bocca quadra, deviatore integrato a molla e doccetta quadrata estraibile in ottone cromato.

Single-lever deck bath/shower mixer Flash series, with squared spout, spring diverter, and squared chrome plated brass pull-out handshower.

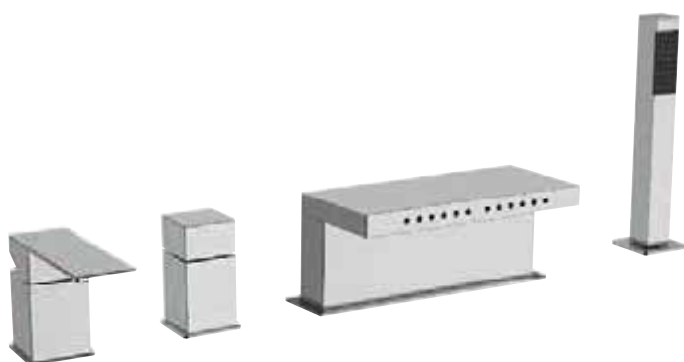

Z 06

Miscelatore monocomando bordo vasca con deviatore, bocca con effetto multigetto e doccetta in ottone cromato.

Single lever deck bath/shower mixer with diverter, spout with multijets effect and c.p. brass hand shower.



ZC 06

Miscelatore monocomando bordo vasca con deviatore, bocca cascata e doccetta in ottone cromato

single lever deck bath/shower mixer with diverter, waterfall spout and c.p. brass hand shower



Nel miscelatore per vasca l'acqua defluisce liberamente da una bocca larga attraverso una fessura creando una vera e propria sensazione di sorgente naturale.

Questo avviene grazie a particolari soluzioni tecniche realizzate internamente ai pezzi.

In the bath mixer, water comes out freely and from a large spout creating a real, true sensation of natural spring. This works thanks to few particular technical solutions realised inside the product.



91 ZC

Bocca incasso a cascata, serie ZC.
Built-in spout ZC series, with waterfall effect.

359 ZC

Soffione doccia con getto a cascata, serie ZC.
C.p. brass shower head, ZC series, with waterfall jet.



Z 30

Miscelatore monocomando da incasso senza deviatore.

Built-in single-lever mixer without diverter.



91 ZCA

Bocca bordo vasca getto a cascata.
Spout for deck bath/shower with waterfall jet.



91 ZCF

Bocca bordo vasca con effetto multigetto.
Spout for deck bath/shower with multijets effect.



Z 09

Miscelatore monocomando da incasso con deviatore per vasca/doccia.

Built-in bath/shower single-lever mixer with diverter.



Z 93 7

Miscelatore monocomando per doccia con deviatore a tre vie e sette posizioni (una entrata, tre uscite e sette posizioni con cui selezionare uscite singole o miscelate tra loro) su unica piastra.

Single lever built-in shower mixer with three ways diverter with seven positions (1 inlet and 3 outlets and seven positions to select single or mixed outlets) on single flange.



Z 39

Miscelatore monocomando esterno per doccia, con set doccia.
Wall mounted single-lever shower mixer, and shower set.

Z 31

Miscelatore monocomando esterno per doccia, senza set doccia.
Wall mounted single-lever shower mixer, without shower set.



Z 40

Miscelatore monocomando per lavello con corpo girevole.
Single lever one-hole sink mixer with swivable body.

Il miscelatore monocomando per lavello "Z 40" è in grado di ruotare su se stesso senza limitazioni angolari grazie ad un particolare elemento tecnico che internamente gestisce questo movimento con la massima precisione.

Questo elemento interno garantisce inoltre un'estrema solidità all'intero miscelatore e una totale mancanza di attrito tra le parti o il piano di appoggio soprattutto durante le rotazioni.

The sink single-lever mixer "Z 40" can rotate on itself without angular limitation thanks to a particular internal technical component that regulates this movement with the maximum accuracy.

This internal element also grants a very good internal strength and avoids any scratching between the internal parts or the kitchen top during the rotation.





Z09 S02

Set doccia composto da:

Art. 359 ZC: Soffione doccia con getto a cascata completamente in ottone cromato.

Art. 337S 317RR 333CN150: Presa acqua deluxe in ottone cromato, doccetta flat in ottone cromato e flessibile doccia conico in ottone cromato.

Art. Z 09: Miscelatore monocomando incasso per doccia con deviatore.

Shower set composed by:

Art. 359 ZC: brass shower head with waterfall jet.

Art. 337S 317RR 333CN150: Water punch with duplex shower holder, flat handshower and conical flexible cm 150, all in c.p. brass.

Art. Z 09: Single lever built-in mixer with diverter.



Z93 7 S02

Set doccia composto da:

Art. 359 ZC: Soffione doccia con getto a cascata completamente in ottone cromato.

Art. Q 34 JET: 6 getti Q idromassaggio anticalcare.

Art. 337S 317RR 333CN150: Presa acqua con supporto doccia duplex, doccetta flat e flessibile conico cm 150 il tutto in ottone cromato.

Art. Z 93 7: Miscelatore monocomando incasso con deviatore a tre vie e sette posizioni su piastra unica.

Shower set composed by:

Art. 359 ZC: brass shower head with waterfall jet.

Art. Q 34 JET: 6 hydromassage anti-limestone jets.

Art. 337S 317RR 333CN150: Water punch with duplex shower holder, flat handshower and conical flexible cm 150, all in c.p. brass.

Art. Z 93 7: Built-in shower mixer with three ways diverter and seven positions on single flange.



Z93 7 S01

Set doccia composto da :

Art. 359 ZC: Soffione doccia con getto a cascata completamente in ottone cromato.

Art. Q 34 JET: 6 getti Q idromassaggio anticalcare.

Art. 317R 317RR 333CN 150: Saliscendi flat con doccetta flat, il tutto in ottone cromato.

Art. 309 S: presa acqua deluxe quadrata.

Art. Z 93 7: Miscelatore monocomando incasso con deviatore a tre vie e sette posizioni su piastra unica.

Shower set composed by :

Art. 359 ZC: brass shower head with waterfall jet.

Art. 317R 317RR 333CN 150: Sliding bar flat model with flat model handshower, all in c.p. brass.

Art. 309 S: Deluxe water punch all in c.p. brass.

Art. Q 34 JET: 6 hydromassage anti-limestone jets.

Art. Z 93 7: Built-in shower mixer with three ways diverter and seven positions on single flange.



Z93 7 S03

Set doccia composto da :

Art. 359 ZC: Soffione doccia con getto a cascata completamente in ottone cromato.

Art. 337S 317RR 333CN150: Presa acqua con supporto doccia duplex, doccetta flat e flessibile conico cm 150 il tutto in ottone cromato.

Art. 91 ZC: Bocca larga a incasso con effetto cascata.

Art. Z 93 7: Miscelatore monocomando incasso con deviatore a tre vie e sette posizioni su piastra unica.

Shower set composed by :

Art. 359 ZC: brass shower head with waterfall jet.

Art. 337S 317RR 333CN150: Water punch with duplex shower holder, flat handshower and conical flexible cm 150, all in c.p. brass.

Art. 91 ZC: Large built-in spout with waterfall effect.

Art. Z 93 7: Built-in shower mixer with three ways diverter and seven positions on single flange.





ATMOS

La linea di Atmos si presenta come plasmata da un vento che, accarezzandone dolcemente tutta la sua superficie, le dona leggerezza ed aerodinamicità. Disegnata da un tratto morbido e continuo, senza alcuna interruzione è di linea, un prodotto dal design pulito, decisamente avvolgente e molto gradevole al tatto. Un progetto senza tempo nato per essere protagonista assoluto in tutte le tipologie di bagno. Il suo profilo è unico e inconfondibile grazie al parallelismo ravvicinato tra maniglia e corpo che danno l'impressione di fondersi in un'unica entità. Questa particolarità tecnico-estetica è solo una delle tante brevettate per questa serie. Infatti si mettono in evidenza anche il tettuccio copri snodo per l'aeratore bidet, i distanziali antisfregamento per le maniglie, i rosoni ad arco per i corpi a muro ed un perno interno a rotazione sospesa per gli elementi cucina.

The Atmos line appears to be shaped by a wind that, giving it lightness and aerodynamics, gently caresses its entire surface. Designed by a soft and continuous line, without interruption, it looks like a compact item, with a clean design, definitely fascinating and very pleasant to touch. A timeless design born to be a protagonist in all types of bathroom. Its profile is unique and unmistakable thanks to the close parallelism between handle and body, giving the impression to merge into a single entity. This technical-aesthetic particular is just one of many others patented for this series. In fact, we also highlight the cap covering the joint for the bidet aerator, the anti-chafing spacers for the handles, the arch flanges for the built-in bodies and a inner suspended rotation pin for the kitchen items.



CARATTERISTICHE TECNICHE:

La serie è dotata di cartuccia a dischi ceramici, Ø 40 mm, tranne art. A 40 e art. A 10 L dotati di cartuccia Ø 35 mm, prodotte da S.T.S.R. - Studio Tecnico Sviluppo e Ricerche - www.stsr.it

Finiture disponibili : cromo, bianco opaco, nero opaco.

TECHNICAL CHARACTERISTICS:

The series is equipped with ceramic cartridge, Ø 40 mm, excluded art. A 40 and art. A 10 L equipped with cartridge Ø 35 mm, produced by S.T.S.R. - Research Development Technical Office - www.stsr.it

Available finishes: chrome, matt white, matt black.



A 10

Miscelatore monocomando per lavabo, con scarico.
Single-lever basin mixer with pop-up waste.

A 11

Miscelatore monocomando per lavabo, senza scarico.
Single-lever basin mixer without pop-up waste.



A 10 L

Miscelatore monocomando alto per lavabo, con scarico click-clack con troppo pieno.

Single-lever basin mixer high neck with click-clack waste with overflow.

A 10 LB

Come A 10 L, con scarico click-clack senza troppo pieno.

As A 10 L, with click-clack waste without overflow.

A 11 L

Come A 10 L, senza scarico.

As A 10 L, without click-clack waste.

Sull'estremità inferiore della leva Atmos sono applicati due distanziatori in materiale morbido e colorato con una duplice funzione:

- Visiva, per indicare con colori rosso e blu la direzione in cui ruotare la maniglia per erogare acqua calda o fredda;
- Funzionale, perchè si appoggiano alla superficie cromata superiore del corpo e preservano la stessa da eventuali graffi causati dai ripetuti movimenti dell'oggetto.

On the lower end of the handle are set two soft touch coloured spacers with a double purpose :

- A visual purpose, with red and blue colours to indicate the direction in which turn the handle to open hot or cold water;
- A functional purpose, preserving the mixer body from scratches that might occur by the continuing handle turning.



PATENTED



A 20

Miscelatore monocomando per bidet, con aeratore direzionabile coperto e schermato e con scarico.

Single-lever bidet mixer with adjustable aerator covered and shielded and with pop-up waste.

A 21

Miscelatore monocomando per bidet, con aeratore direzionabile coperto e schermato e senza scarico.

Single-lever bidet mixer with adjustable aerator covered and shielded and without pop-up waste.



PATENTED

Il tettuccio copriaeratore ha il duplice vantaggio sia di coprire una parte funzionale rendendo l'oggetto più elegante che di preservare la stessa da eventuali urti rendendo l'oggetto più resistente e duraturo.

The bidet shape has been studied to give a real attractive design. The full cover over the aerator has the double advantage to hide the functional part making the item more elegant and to preserve the same part from eventual hits keeping the object more resistant and long-lasting.



A 02

Miscelatore monocomando per vasca, esterno, con rosone ad arco "full cover" e con set doccia duplex "torch".

Single-lever external bath mixer, with "full cover" flange and duplex shower set "torch".

A 05

Miscelatore monocomando per vasca, esterno, con rosone ad arco "full cover" senza set doccia.

Single-lever external bath mixer, with "full cover" flange without shower set.



A 38

Miscelatore monocomando esterno per doccia con leva frontale, con rosone ad arco "full cover" e con set doccia duplex "torch".

Wall mounted single-lever shower mixer, with frontal lever, "full cover" flange and duplex shower set "torch".

A 33

Miscelatore monocomando esterno per doccia con leva frontale e con rosone ad arco "full cover" senza set doccia.

Wall mounted single-lever shower mixer, with frontal lever, "full cover" flange without shower set.



PATENTED

Il rosone ad arco "full cover" è stato pensato e disegnato per abbinarsi alle linee dei corpi dei miscelatori vasca e doccia con i quali e' accoppiato. Essendo un unico pezzo copre totalmente le parti di fissaggio a differenza dei normali rosoni singoli.

The "full cover" arc rose has been studied and realized to match the bath and shower mixers design with which it is coupled.

Differently from the usual single flanges, it completely covers the fixing components, as it is a unique piece.









A 09 V

Miscelatore monocomando da incasso con deviatore per vasca/doccia.
Built-in bath/shower single-lever mixer with diverter.



A 30 V

Miscelatore monocomando da incasso senza deviatore.
Built-in single lever mixer without diverter.



A 09

Miscelatore monocomando da incasso con deviatore per vasca/doccia.
Built-in bath/shower single-lever mixer with diverter.



A 30

Miscelatore monocomando da incasso senza deviatore.
Built-in single-lever mixer without diverter.



Il miscelatore monocomando da incasso possiede una particolare forma a "V" rovesciata. Quando la maniglia viene ruotata nelle sue posizioni di acqua calda e fredda alla massima apertura, questa si allinea con la piastra cromata sottostante.

The built-in single-lever mixer has a special upside-down "V" shape. When the handle turns into the widest opened positions of cold or hot water, it aligns with the chrome plated plate below.





A 09V S06

Art. 348N30 + 359MM30: braccio doccia in ottone cromato con soffione minimale in ottone cromato anticalcare Ø 30.

Art. N34 JET: 6 getti minimali anticalcare.

Art. A 09 V: Miscelatore incasso doccia con deviatore.

Versione con piastra incasso A 09 codice A 09 S06

Art. 348N30 + 359MM30: c.p. brass shower arm with minimal anti-limestone showerhead in c.p. brass Ø 30.

Art. N34 JET: 6 minimal jets anti-limestone.

Art. A 09 V: Built-in shower mixer with diverter.

Version with built-in shower art.A 09 with code A 09 S06



A 09V S07

Art. 348N30 + 359MM30: braccio doccia in ottone cromato con soffione minimale in ottone cromato anticalcare Ø 30.

Art. 310M 317TH: saliscendi con doccetta Torch e flessibile conico in ottone cromato cm 150.

Art. 309 L: presa acqua deluxe in ottone cromato.

Art. A 09 V: Miscelatore incasso doccia con deviatore.

Versione con piastra incasso A 09 codice A 09 S07

Art. 348N30 + 359MM30: c.p. brass shower arm with minimal anti-limestone showerhead in c.p. brass Ø 30.

Art. 310M 317TH: sliding bar anti-limestone handshower and one conical nut c.p. brass flexible cm 150.

Art. 309L: deluxe water punch in c.p. brass.

Art. A 09 V: Built-in shower mixer with diverter.

Version with built-in shower art.A 09 with code A 09 S06

KITCHEN



A 40

Miscelatore monocomando per lavello con corpo girevole.

Single lever one-hole sink mixer with swivable body.



PATENTED

Il miscelatore monocomando per lavello "A 40" è in grado di ruotare su se stesso senza limitazioni angolari grazie ad un particolare elemento tecnico che internamente gestisce questo movimento con la massima precisione. Questo elemento interno garantisce inoltre un'estrema solidità all'intero miscelatore e una totale mancanza di attrito tra le parti o il piano di appoggio soprattutto durante le rotazioni.

The sink single-lever mixer "A 40" can rotate on itself without angular limitation thanks to a particular internal technical component that regulates this movement with the maximum accuracy.

This internal element also grants a very good internal strength and avoids any scratching between the internal parts or the kitchen top during the rotation.



QUBIKA

Il design di Qubika ha un carattere elegante ed una bellezza immediata.

La base quadrata viene armonicamente intersecata dalle bocche rettangolari di spessore minimo. Ogni singolo componente si armonizza col precedente in un gioco di angoli vivi che scolpiscono l'oggetto e ne delineano le caratteristiche di essenzialità e forte impatto estetico. Una serie dalla modernità spiccata e minimale.

The design of Qubika has an elegant character and an immediate beauty.

The square base is harmonically intersected by the rectangular spouts of minimum thickness. Each single component is in harmony with the previous one in a game of sharp angles sculpting the object and delineating the characteristics of simplicity and strong visual impact. A series of high and minimal modernity.





CARATTERISTICHE TECNICHE:

La serie è dotata di cartuccia a dischi ceramici, Ø 35 mm, prodotta da S.T.S.R. - Studio Tecnico Sviluppo e Ricerche - www.stsr.it.

Finiture disponibili : cromo, bianco opaco, nero opaco.

TECHNICAL CHARACTERISTICS:

The series is equipped with ceramic cartridge, Ø 35 mm, produced by S.T.S.R. - Research Development Technical Office - www.stsr.it.

Available finishes: chrome, matt white, matt black.



Q 10

Miscelatore monocomando per lavabo, con scarico.
Single-lever basin mixer with pop-up waste.

Q 11

Miscelatore monocomando per lavabo, senza scarico.
Single-lever basin mixer without pop-up waste.



Q 10 L

Miscelatore monocomando alto per lavabo, con scarico click-clack, con troppo pieno.

Single-lever basin mixer high neck with click-clack waste with overflow.

Q 10 L B

Come Q 10 L, con scarico click-clack senza troppo pieno.

As Q 10 L, with click-clack waste without overflow.

Q 11 L

Come Q 10 L, senza scarico.

Means above Q 10 L, without click-clack waste.

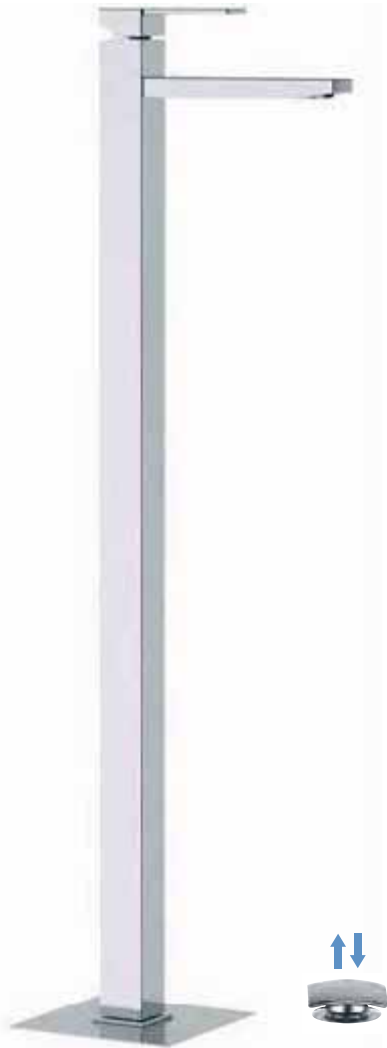

Q 18

Miscelatore monocomando lavabo da terra, altezza bocca cm 95, con scarico click-clack con troppo pieno.

Single-lever mixer for floor mounting, spout height cm 95, with click-clack waste with overflow.



Q 14

Miscelatore monocomando a incasso per lavabo, con piastra verticale rettangolare in ottone cromato e bocca qubika lunghezza cm 18.

Single lever built-it basin mixer, with vertical rectangular wall flange in chrome plated brass and qubika spout length cm 18.



Q 15

Miscelatore monocomando a incasso per lavabo, con piastra rettangolare in ottone cromato e bocca qubika lunghezza cm 18.

Single lever built-it basin mixer, with rectangular wall flange in chrome plated brass and qubika spout length cm 18.



Q 63

Miscelatore incasso per shut-off.

Built-in shut-off mixer.



Q 60

Miscelatore incasso per shut-off comprensivo di : doccetta shut-off ns art 332 OS, supporto doccia- presa acqua su piastra in ottone cromato e flessibile doccia cm 120.

Built-in shut-off mixer set including : shut-off art 332 OS, shower holder-water punch on flange, all in c.p. brass and shower flexible cm 120.





QUBIKA



Q 20

Miscelatore monocomando per bidet, con aeratore direzionabile, tettuccio di protezione e con scarico.

Single-lever bidet mixer with adjustable aerator, covered and shielded and pop-up waste.

Q 21

Come Q 20, senza scarico.

Means above Q 20, without pop-up waste.



Q 23

Miscelatore monocomando per bidet, con doccetta.

Single-lever bidet mixer with shower.



Q 10 G

Miscelatore monocomando per lavabo, con canna corta a "U" girevole, con scarico click-clack, con troppo pieno.

Single-lever one-hole basin mixer, with short "U" movable spout, with click clack system and overflow.



Q 10 GL

Miscelatore monocomando alto per lavabo, con canna corta a "U" girevole, con scarico click-clack, con troppo pieno.

High single-lever one-hole basin mixer, with short "U" movable spout, with click clack system and overflow.



Q 10 GLXL

Miscelatore monocomando alto per lavabo, con canna lunga a "U" girevole, con scarico click-clack, con troppo pieno.

High single-lever one-hole basin mixer, with long "U" movable spout, with click clack system and overflow.





Q 02

Miscelatore monocomando per vasca, esterno, con doccia duplex.
Wall mounted single-lever bath mixer, with duplex shower.

Q 05

Miscelatore monocomando per vasca, esterno, senza kit doccia.
Wall mounted single-lever bath mixer, without shower kit.



Q 07

Miscelatore monocomando bordo vasca serie Qubika con bocca quadra, deviatore integrato a molla e doccetta quadrata estraibile in ottone cromato.

Single-lever deck bath mixer Qubica series, with squared spout, spring diverter, and squared chrome plated brass pull-out handshower.



Q 03

Miscelatore monoforo lavabo/vasca, con deviatore integrato e kit doccia.
Single lever one-hole basin/bath mixer with diverter and shower kit.



Q 04

Miscelatore monocomando per vasca da incasso, su piastra rettangolare, con bocca lunga cm 18 con deviatore e kit doccia integrato.

Single-lever built-in bath mixer, with rectangular wall flange, spout long 18cm with diverter and integrated shower kit



Q 08

Miscelatore vasca da pavimento, altezza bocca cm 85, con deviatore e kit doccia.

Single-lever bath mixer floor mounting, spout height cm 85, with diverter and shower kit.





QC 06

Miscelatore monocomando bordo vasca con deviatore, bocca cascata e doccia in ottone cromato
single lever deck bath/shower mixer with diverter, waterfall spout and c.p. brass hand shower

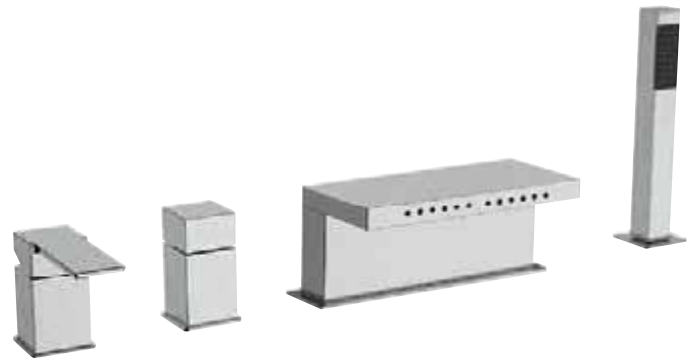

Q 06

Miscelatore monocomando bordo vasca con deviatore, bocca con effetto multigetto e doccia in ottone cromato.
Single lever deck bath/shower mixer with diverter, spout with multijets effect and c.p. brass hand shower.



91 ZCA

Bocca bordo vasca getto a cascata.
Spout for deck bath/shower with waterfall jet.



91 ZCF

Bocca bordo vasca con effetto multigetto.
Spout for deck bath/shower with multijets effect.



91 ZC

Bocca incasso a cascata, serie ZC.
Built-in spout ZC series, with waterfall effect.



91 Q

Bocca incasso serie Q, cm 18.
Built-in spout Q serie, cm 18.



91 QD

Bocca incasso serie Q, con deviatore integrato, cm 18.
Built-in spout Q serie, with diverter, cm 18.



Q 30

Miscelatore monocomando da incasso senza deviatore per doccia.

Built-in shower single lever mixer without diverter.



Q 93

Miscelatore monocomando per doccia con deviatore a tre vie (una entrata e tre uscite) su unica piastra.

Single lever built-in shower mixer with three ways diverter (1 inlet and 3 outlets) on single flange.



Q 09

Miscelatore monocomando da incasso con deviatore per vasca/doccia.

Built-in bath/shower single-lever mixer with diverter.

Q 93 7

Miscelatore monocomando per doccia con deviatore a tre vie e sette posizioni (una entrata, tre uscite e sette posizioni con cui selezionare uscite singole o miscelate tra loro) su unica piastra.

Scatti della maniglia-deviatore:

- lo scatto 1 aziona l'acqua dell'uscita 1
- lo scatto 2 aziona l'acqua dell'uscita 2
- lo scatto 3 aziona l'acqua dell'uscita 3
- lo scatto 4 aziona l'acqua dell'uscita 1
- lo scatto 5 aziona l'acqua delle uscite 1 + 2
- lo scatto 6 aziona l'acqua delle uscite 1 + 2 + 3
- lo scatto 7 aziona l'acqua delle uscite 2 + 3

Single lever built-in shower mixer with three ways diverter with seven positions (1 inlet and 3 outlets and seven positions to select single or mixed outlets) on single flange.



Q 92

Miscelatore monocomando per doccia, con deviatore a due posizioni (due uscite ed una entrata) su piastra unica.

Single-lever shower mixer with 2 positions diverter (2 outlets and 1 inlet) on single flange.

Handle steps of the diverter :

- 1st step to run water from outlet 1
- 2nd step to run water from outlet 2
- 3rd step to run water from outlet 3
- 4th step to run water from outlet 1
- 5th step to run water from outlets 1 + 2
- 6th step to run water from outlets 1 + 2 + 3
- 7th step to run water from outlets 2 + 3



Q 94

Miscelatore monocomando per doccia, con deviatore a 4 posizioni (4 uscite ed 1 entrata) su piastra unica.

Single-lever shower mixer with 4 positions diverter (4 outlets and 1 inlet) on single flange.

Q 95

Miscelatore monocomando per doccia, con deviatore a 5 posizioni (5 uscite ed una entrata) su piastra singola.

Single-lever shower mixer with 5 positions diverter (5 outlets and 1 inlet) on single flange.



Q 94 C

Miscelatore monocomando per doccia, con deviatore a 4 posizioni (4 uscite ed una entrata) su doppia piastra, con possibilità di chiusura del flusso dal deviatore durante il cambio di posizione (col vantaggio di non azionare posizioni non desiderate e non dover toccare la maniglia che seleziona anche la temperatura).

Single-lever shower mixer with 4 positions diverter (4 outlets and 1 inlet,) on double flange, with the possibility of closing the flow from the diverter during the position change (with the advantage of not starting the undesired positions and also not be forced to touch the handle that also selects the temperature).

Q 95 C

Miscelatore monocomando per doccia, con deviatore a 5 posizioni (5 uscite ed una entrata) su doppia piastra, con possibilità di chiusura del flusso dal deviatore durante il cambio di posizione (col vantaggio di non azionare posizioni non desiderate e non dover toccare la maniglia che seleziona anche la temperatura).

Single-lever shower mixer with 5 positions diverter (5 outlets and 1 inlet,) on double flange, with the possibility of closing the flow from the diverter during the position change (with the advantage of not starting the undesired positions and also not be forced to touch the handle that also selects the temperature).





317S 317SQ

Saliscendi quadro completamente in ottone con doccetta minimale SQ in abs cromato e flessibile conico in ottone cromato cm 150.

SQ sliding bar completely in c.p. brass, with handshower SQ in c.p. abs and one conical nut shower flexible cm 150.



Q 36

Set doccia composto da:

Miscelatore esterno doccia **Q 35** con colonna doccia quadra con soffione completamente in ottone cromato e anticalcare **359SS**.

Shower set composed by:

External shower single lever mixer **Q 35** with squared shower column with showerhead all in c.p. brass art. **359SS** with silicone jets, anti-limestone.



Q 31

Miscelatore monocomando esterno per doccia.

Wall mounted single-lever shower mixer.



Q 39

Miscelatore monocomando esterno per doccia, con doccia duplex.

Wall mounted single-lever shower mixer, with duplex shower.



Q 35

Gruppo doccia a muro, con attacco alto da 3/4" per colonna doccia.

Wall mounted shower mixer, with upper 3/4" connection pipe shower column.



Q 37

Set doccia composto da:

Miscelatore esterno doccia **Q 35** con colonna doccia quadra con saliscendi e deviatore, doccetta **317 SQ** e soffione completamente in ottone **359 SS**. Flessibile in ottone cromato incluso.

Shower set composed by:

External shower single lever mixer **Q 35** with squared shower column with sliding central and diverter, including handshower **317 SQ** and showerhead all in c.p. brass **359 SS**. Shower flexible in c.p. brass included.



Q 37 XL

Set doccia composto da:

Miscelatore esterno doccia **Q 35** con colonna doccia quadra con saliscendi e deviatore, doccetta **317 SQ** e soffione completamente in ottone cromato **359 SS XL**. Flessibile in ottone cromato incluso.

Shower set composed by:

External shower single lever mixer **Q 35** with squared shower column with sliding central and diverter, including handshower **317 SQ** and showerhead all in c.p. brass **359 SS XL**. Shower flexible in c.p. brass included.

QUBIKA WELLNESS



Q 09 S01

Set doccia composto da:

Art. 359SS 348S 30: Soffione SQ in ottone anticalcare con braccio quadro in ottone cm 30.

Art. 317S 317SQ: Saliscendi quadro con doccetta Q anticalcare e flessibile conico in ottone cromato cm 150.

Art. 309 S: Presa acqua lusso quadrata.

Art. Q 09: Miscelatore incasso con deviatore.

Disponibile con braccio a soffitto con codice Q 09 S21

Shower set composed by:

Art. 359SS 348S 30: SQ showerhead in c.p. brass anti-limestone with squared arm in brass cm 30.

Art. 317S 317SQ: SQ sliding bar with Q anti-limestone handshower with shower flexible hose in brass cm 150.

Art. 309 S: Lux water punch SQ type.

Art. Q 09: Built-in mixer with diverter.

Available with ceiling arm with code Q 09 S21



Q 09 S02

Set doccia composto da:

Art. 359SS 348S30: Soffione SQ in ottone anticalcare con braccio quadro in ottone cm 30.

Art. 337S: Supporto doccia deluxe duplex con presa acqua.

Art. 317SQ con 333CN150 con doccetta Q anticalcare e flessibile conico in ottone cromato cm 150.

Art. Q 09: Miscelatore incasso con deviatore.

Disponibile con braccio a soffitto con il codice Q 09 S22

Shower set composed by:

Art. 359SS 348S30: SQ showerhead in c.p. brass anti-limestone with squared arm in brass cm 30.

Art. 337S: Duplex deluxe shower holder with water punch in c.p. brass
Art. 317SQ with 333CN150 anti-limestone Q handshower with shower flexible hose in brass cm 150.

Art. Q 09: Built-in mixer with diverter.

Available with ceiling arm with code Q 09 S22



Q 09 S03

Set doccia composto da:

Art. 359SS 348S30: Soffione SQ in ottone anticalcare con braccio quadro in ottone cm 30.

Art. 339S 317SQ con 333CN 150: Supporto doccia cromato con doccetta Q anticalcare e flessibile conico in ottone cromato cm 150

Art. 91 QD: Bocca incasso Q con deviatore.

Art. Q 09: Miscelatore incasso con deviatore.

Disponibile con braccio a soffitto con codice Q 09 S23

Shower set composed by:

Art. 359SS 348S30: SQ showerhead in c.p. brass anti-limestone with squared arm in brass cm 30.

Art. 339S 317SQ with 333CN 150: c.p. shower holder with anti-limestone Q handshower with shower flexible hose in brass cm 150

Art. 91QD: Built-in spout serie Q with diverter.

Art. Q 09: Built-in mixer with diverter.

Available with ceiling arm with code Q 09 S23



Q 09 S11

Set doccia composto da:

Art. 330S 359 SS 317SQ 333CN 150: Colonna doccia a barra quadrata, deluxe, con deviatore e saliscendi, soffione doccia quadrato in ottone con getti in silicone anticalcare, doccetta serie Qubika anticalcare, flessibile doccia conico in ottone.

Art. 330S RA: Supporto quadro per colonna doccia e presa acqua.

Art. 91 Q: Bocca incasso vasca/ doccia serie Qubika.

Art. Q 09: Miscelatore incasso con deviatore.

Shower set composed by:

Art. 330S 359 SS 317SQ 333CN 150: Squared bar deluxe shower column, with diverter and sliding part, squared shower head in brass with silicone jets, anti-limestone, Qubika anti-limestone handshower, conical nut flexible hose in brass.

Art. 330S RA: Squared water punch and holder for SQ columns.

Art. 91 Q: Built-in spout for bath-shower serie Q.

Art. Q 09: Built-in mixer with diverter.



Q 93 7 S01

Set doccia composto da:

Art. 359SS 348S30: Soffione SQ in ottone anticalcare con braccio quadro in ottone cm 30.

Art. 317S 317SQ: saliscendi Q in ottone cromato con doccetta Q anticalcare e flessibile conico in ottone cromato cm 150

Art. 309S: Presa acqua Q in ottone cromato.

Art. Q 34 JET: 6 getti anticalcare Q in ottone cromato.

Art. Q 93 7: Miscelatore incasso con deviatore a tre vie e sette posizioni su piastra unica.

Disponibile con braccio a soffitto con il codice Q 93 7 S21

Shower set composed by:

Art. 359SS 348S30: SQ showerhead in c.p. brass anti-limestone with squared arm in brass cm 30.

Art. 317S317SQ: Q sliding bar in c.p. brass and anti-limestone Q handshower with shower flexible hose in brass cm 150

Art. 309S: Deluxe Q water punch, in c.p. brass.

Art. Q 34 JET: 6 jets anti-limestone in c.p. brass.

Art. Q 93 7: Built-in mixer with three ways diverter with seven positions on single flange

Available with ceiling arm with code Q 93 7 S21



Q 93 7 S02

Set doccia composto da:

Art. 359SS 348S30: Soffione SQ in ottone anticalcare con braccio quadro in ottone cm 30.

Art. 337 S: Supporto doccia deluxe duplex con presa acqua.

Art. 317SQ con 333CN 150: con doccetta Q anticalcare e flessibile conico in ottone cromato cm 150.

Art. Q 34 JET: 6 getti anticalcare Q in ottone cromato.

Art. Q 93 7: Miscelatore incasso con deviatore a tre vie e sette posizioni su piastra unica.

Disponibile con braccio a soffitto con il codice Q 93 7 S22

Shower set composed by:

Art. 359SS 348S30: SQ showerhead in c.p. brass anti-limestone with squared arm in brass cm 30.

Art. 337S: Duplex deluxe shower holder with water punch in c.p. brass
Art. 317SQ with 333CN 150: anti-limestone Q handshower with shower flexible hose in brass cm 150.

Art. Q 34 JET: 6 jets anti-limestone in c.p. brass.

Art. Q 93 7: Built-in mixer with three ways diverter with seven positions on single flange.

Available with ceiling arm with code Q 93 7 S22



Q 93 7 S03

Set doccia composto da:

Art. 359SS 348S30: Soffione SQ in ottone anticalcare con braccio quadro in ottone cm 30.

Art. 337 S: Supporto doccia deluxe duplex con presa acqua.

Art. 317SQ con 333CN 150: con doccetta Q anticalcare e flessibile conico in ottone cromato cm 150.

Art. 91 Q: Bocca incasso serie Q.

Art. Q 93 7: Miscelatore incasso con deviatore a tre vie e sette posizioni su piastra unica.

Disponibile con braccio a soffitto con il codice Q 93 7 S23

Shower set composed by:

Art. 359SS 348S30: SQ showerhead in c.p. brass anti-limestone with squared arm in brass cm 30.

Art. 337S: Duplex deluxe shower holder with water punch in c.p. brass

Art. 317SQ with 333CN150: anti-limestone Q handshower with shower flexible hose in brass cm 150.

Art. 91 Q: Built-in spout Q serie.

Art. Q 93 7: Built-in mixer with three ways diverter with seven positions on single flange.

Available with ceiling arm with code Q 93 7 S23



Q 30 S11

Set doccia composto da:

Art. 330S 359 SS 317SQ 333CN 150: Colonna doccia a barra quadrata, deluxe, con deviatore e saliscendi, soffione doccia quadrato in ottone con getti in silicone anticalcare, doccetta serie Qubika anticalcare, flessibile doccia conico in ottone.

Art. 330S RA: Presa acqua-attacco a muro quadrato.

Art. Q 30: Miscelatore incasso doccia Qubika.

Shower set composed by:

Art. 330S 359 SS 317SQ 333CN 150: Squared bar deluxe shower column, with diverter and sliding part, squared shower head in brass with silicone jets, anti-limestone, Qubika anti-limestone handshower, conical nut flexible hose in brass.

Art. 330S RA: Squared water punch and wall connection.

Art. Q30: Built-in single-lever shower mixer Qubika.





Q 40

Miscelatore monocomando per lavello, corpo quadrato e completamente girevole.
Single lever one-hole squared sink mixer with entirely movable body.



Q 42 U

Miscelatore monocomando per lavello, con bocca alta a "U" girevole.
Single-lever one-hole sink mixer with high "U" movable spout.



Q 41

Miscelatore monocomando esterno per lavello con bocca girevole squadrata.
Single-lever wall mounted sink mixer, with movable squared spout.



QUBIKA THERMO

La linea termostatica Qubika completa e definisce le sinergie tra elementi che hanno la stessa valenza progettuale e quindi intercambiabilità estetica ma presentano funzionamenti differenti per soddisfare ogni esigenza di utilizzo. La serie termostatica attribuisce quindi quel valore aggiunto al miscelatore, dotandolo anche della funzione di esatta selezione della temperatura.

The Qubika thermostatic line completes and defines the synergy between elements that have the same design value and therefore interchangeable aesthetics but have different capabilities to meet any design and usage need. The thermostatic series then gives to the mixer an added value, also equipping it with the function of exact temperature selection.

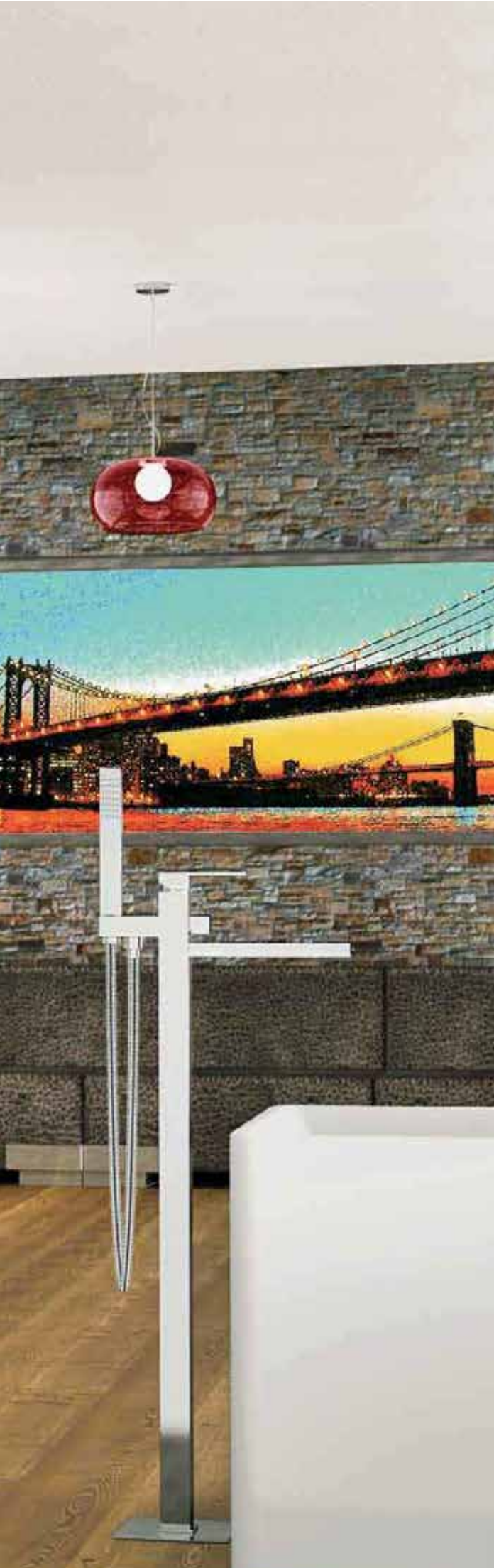

QUBIKA THERMO

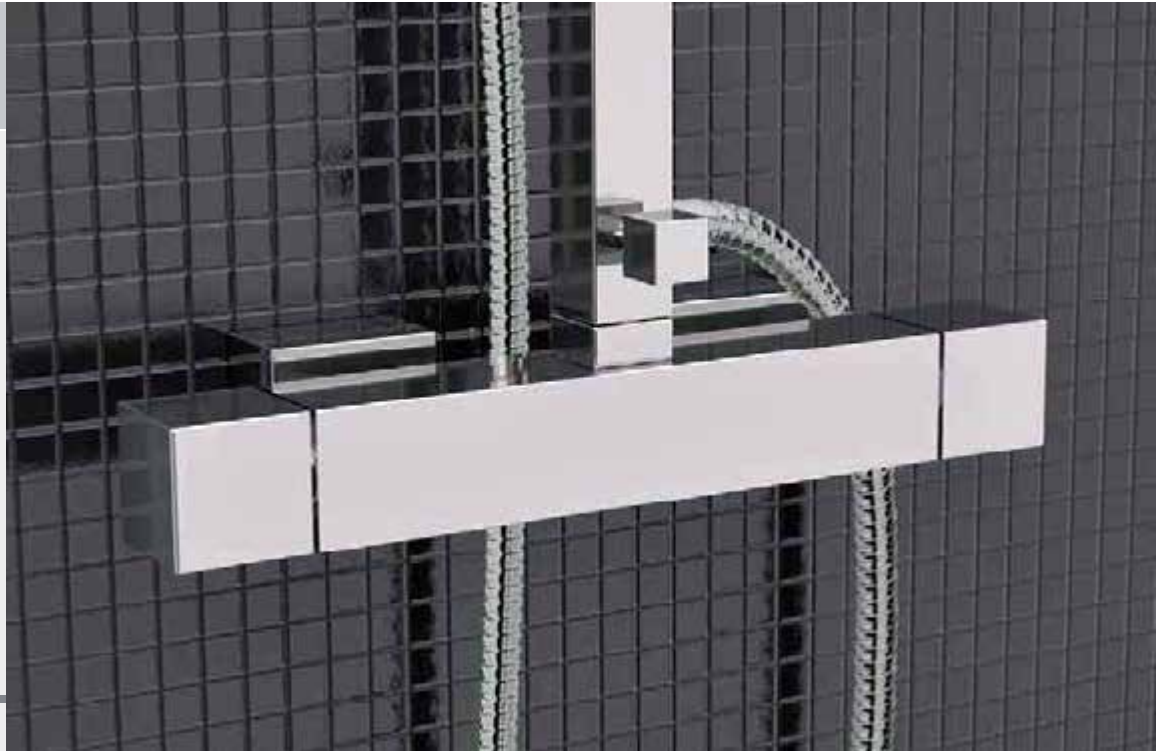

CARATTERISTICHE TECNICHE:

La serie è dotata di cartuccia termostatica prodotta da S.T.S.R. - Studio Tecnico Sviluppo e Ricerche - www.stsr.it.

Finiture disponibili : cromo, bianco opaco, nero opaco.

TECHNICAL CHARACTERISTICS:

The series is equipped with thermostatic cartridge produced by S.T.S.R. - Research Development Technical Office - www.stsr.it.

Available finishes: chrome, matt white, matt black



QT 35

Gruppo doccia a muro termostatico, con attacco alto da 3/4".

Thermostatic wall mounted shower mixer, with upper 3/4" connection.



QT 31

Miscelatore termostatico esterno per doccia, con attacco inferiore da 1/2".

Thermostatic wall mounted shower mixer with lower 1/2" connection.



QT 35 V

Gruppo doccia a muro termostatico verticale, con attacco alto da 3/4".

Vertical thermostatic wall mounted shower mixer, with upper 3/4" connection.



QT 39

Miscelatore termostatico esterno per doccia, con doccia duplex.

Thermostatic wall mounted shower mixer, with duplex shower.



Caratteristiche Tecniche serie Qubika Thermo

- Rotazione della manopola: 330° angolari
- Blocco di sicurezza: 38°C
- Campo di lavoro: da 5°C a 80°C
- Differenziale termico consigliato 50°C
- Campo di pressione in rete: da 1 a 10 bar (consigliato da 1 a 5 bar dinamici)
- Sistema di sicurezza con blocco dell'erogazione in caso di mancanza di una delle due acque
- Alta erogazione (circa 30 litri) in uscita libera

Technical data Qubika Thermo Serie

- Handle rotation: 330° angular
- Safety lock: 38°C
- Working field: from 5°C to 80°C
- Suggested thermic differential between cold and hot water: 50°C
- Pressure field: from 1 to 10 bar (suggested from 1 to 5 bar dynamic)
- Safety system with the outlet lock in case there is one water lock
- High flow rate (about 30 liters) in free outlet

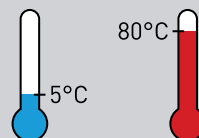
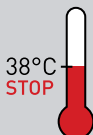

QT 37

Set doccia composto da:

Miscelatore termostatico esterno doccia **QT 35** con colonna doccia quadra con saliscendi e deviatore, doccetta anticalcare **317SQ** e soffione completamente in ottone cromato e anticalcare **359SS**. Flessibile in ottone cromato incluso.

Shower set composed by:

External thermostatic shower single lever mixer **QT 35** with squared shower column with sliding central and diverter, including anti-limestone handshower **317SQ** and showerhead all in c.p. brass **359SS** with silicone jets, anti-limestone. Shower flexible in c.p. brass included.



QT 37 XL

Set doccia composto da:

Miscelatore termostatico esterno doccia **QT 35** con colonna doccia quadra con saliscendi e deviatore, doccetta anticalcare **317 SQ** e soffione completamente in ottone cromato e anticalcare **359 SS XL**. Flessibile in ottone cromato incluso.

Shower set composed by:

External thermostatic shower single lever mixer **QT 35** with squared shower column with sliding central and diverter, including anti-limestone handshower **317 SQ** and showerhead all in c.p. brass **359 SS XL** with silicone jets, anti-limestone. Shower flexible in c.p. brass included.

QUBIKA THERMO



QT 36

Set doccia composto da:

Miscelatore termostatico esterno doccia **QT 35 V** con deviatore, flessibile e doccia **317 RR**, con colonna doccia quadra con soffione completamente in ottone cromato e anticalcare **359SS**.

Shower set composed by:

External thermostatic shower single lever mixer **QT 35 V** with diverter, flexible and handshower **317 RR**, and with squared shower column with showerhead all in c.p. brass **359SS** with silicone jets, anti-limestone.



QT 36 XL

Set doccia composto da:

Miscelatore termostatico esterno doccia **QT 35 V** con deviatore, flessibile e doccia in ottone **317 RR**, con colonna doccia quadra con soffione completamente in ottone cromato e anticalcare **359 SS XL**.

Shower set composed by:

External thermostatic shower single lever mixer **QT 35 V** with diverter, flexible and handshower in brass **317 RR**, and with squared shower column with showerhead all in c.p. brass **359 SS XL** with silicone jets, anti-limestone.

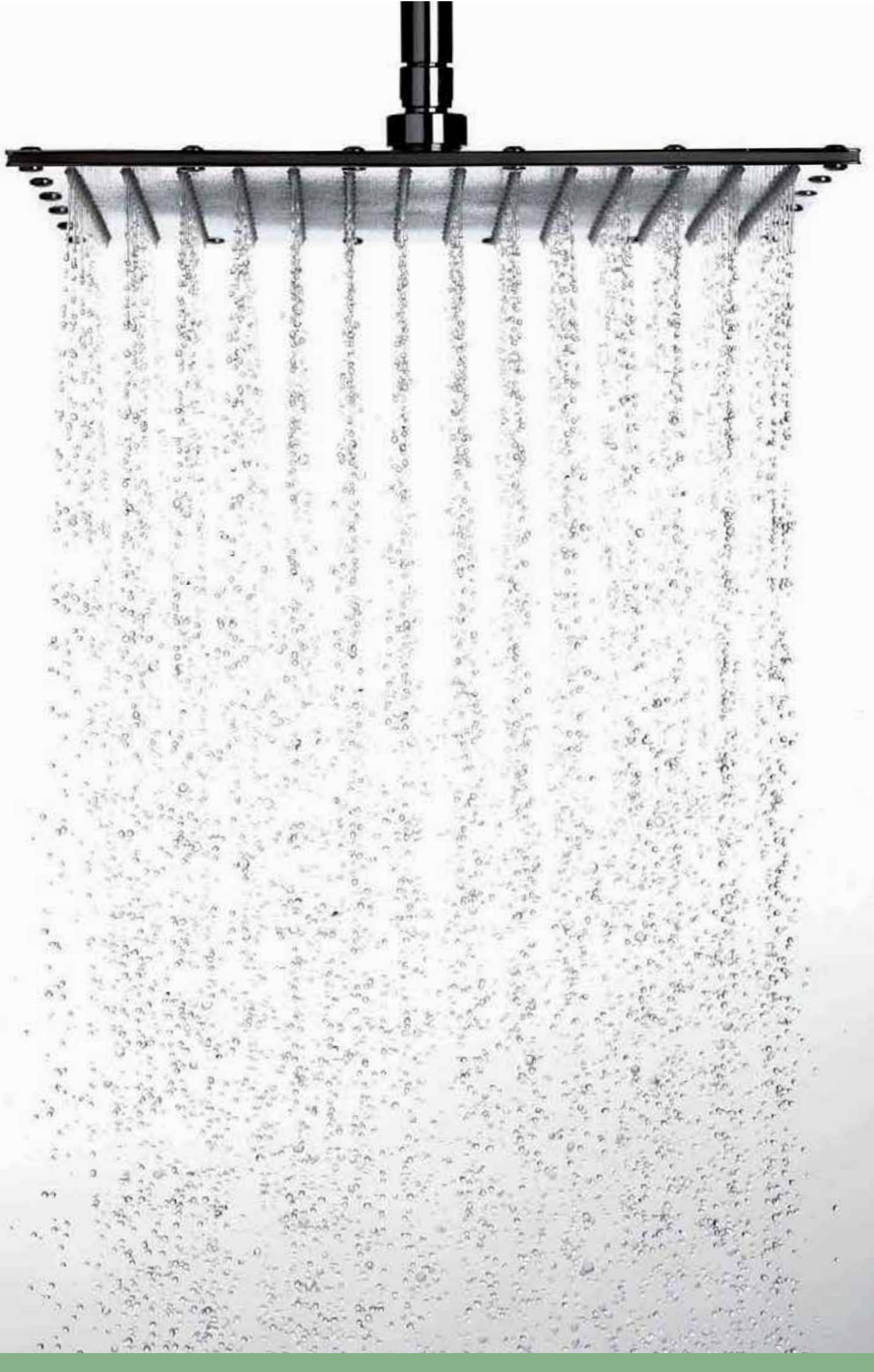



QT 30

Miscelatore termostatico da incasso per doccia, senza deviatore.

Thermostatic built-in mixer for shower, without diverter.



QT 93

Miscelatore termostatico per doccia con deviatore a tre vie (una entrata e tre uscite) su unica piastra.

Thermostatic built-in shower mixer with three ways diverter (1 inlet and 3 outlets) on single flange.



QT 09

Miscelatore termostatico da incasso con deviatore per vasca-doccia.

Thermostatic built-in single-lever mixer, with diverter for bath-shower.

QT 93 7

Miscelatore termostatico per doccia con deviatore a tre vie e sette posizioni (una entrata, tre uscite e sette posizioni con cui selezionare uscite singole o miscelate tra loro) su unica piastra.

Scatti della maniglia-deviatore:

- lo scatto 1 aziona l'acqua dell'uscita 1
- lo scatto 2 aziona l'acqua dell'uscita 2
- lo scatto 3 aziona l'acqua dell'uscita 3
- lo scatto 4 aziona l'acqua dell'uscita 1
- lo scatto 5 aziona l'acqua delle uscite 1 + 2
- lo scatto 6 aziona l'acqua delle uscite 1 + 2 + 3
- lo scatto 7 aziona l'acqua delle uscite 2 + 3

Thermostatic built-in shower mixer with three ways diverter with seven positions (1 inlet and 3 outlets and seven positions to select single or mixed outlets) on single flange.



Handle steps of the diverter :

- 1st step to run water from outlet 1
- 2nd step to run water from outlet 2
- 3rd step to run water from outlet 3
- 4th step to run water from outlet 1
- 5th step to run water from outlets 1 + 2
- 6th step to run water from outlets 1 + 2 + 3
- 7th step to run water from outlets 2 + 3

QT 92

Miscelatore termostatico per doccia, con deviatore a due posizioni (due uscite ed una entrata) su piastra unica.

Thermostatic shower mixer with 2 positions diverter (2 outlets and 1 inlet) on single flange.



QT 94

Miscelatore termostatico per doccia, con deviatore a 4 posizioni (4 uscite ed 1 entrata) su piastra unica.

Thermostatic shower mixer with 4 positions diverter (4 outlets and 1 inlet) on single flange.

QT 95

Miscelatore termostatico per doccia, con deviatore a 5 posizioni (5 uscite ed una entrata) su piastra unica.

Thermostatic shower mixer with 5 positions diverter (5 outlets and 1 inlet) on single flange.



QT 94 C

Miscelatore termostatico per doccia, con deviatore a 4 posizioni (4 uscite ed 1 entrata) su doppia piastra, con possibilità di chiusura del flusso dal deviatore durante il cambio di posizione (col vantaggio di non azionare posizioni non desiderate e non dover toccare la maniglia che seleziona anche la temperatura).

Thermostatic shower mixer with 4 positions diverter (4 outlets and 1 inlet) on double flange, with the possibility of closing the flow from the diverter during the position change (with the advantage of not starting the undesired positions and also not having to touch the handle that also selects the temperature).

QT 95 C

Miscelatore termostatico per doccia, con deviatore a 5 posizioni (5 uscite ed una entrata) su doppia piastra, con possibilità di chiusura del flusso dal deviatore durante il cambio di posizione (col vantaggio di non azionare posizioni non desiderate e non dover toccare la maniglia che seleziona anche la temperatura).

Thermostatic shower mixer with 5 positions diverter (5 outlets and 1 inlet) on double flange, with the possibility of closing the flow from the diverter during the position change (with the advantage of not starting the undesired positions and also not having to touch the handle that also selects the temperature).

La cartuccia termostatica usata all'interno dei nostri articoli QT93 e QT93 7 è completamente intercambiabile con la nostra cartuccia standard da 40mm art S52. Questo consente a distanza di tempo e per qualsiasi Vostra necessità di variare l'impianto da termostatico in tradizionale o viceversa, rendendo un ottimo servizio in termini di sicurezza sulla funzionalità.

The thermostatic cartridge used in our articles QT93 and QT 93 7 is completely interchangeable with our standard Ø 40mm cartridge art. S52. This system allows in time and for any of Your needs to change the installation from thermostatic to traditional or the contrary, giving the best service in terms of safety on functionality.

QUBIKA THERMO WELLNESS



QT 09 S01

Set doccia composto da:

Art. 359SS 348S 30: Soffione SQ in ottone anticalcare con braccio quadro in ottone cm 30.

Art. 317S 317SQ con **333CN 150:** Saliscendi quadro con doccetta Q anticalcare e flessibile conico in ottone cromato cm 150.

Art. 309 S: Presa acqua lusso quadrata.

Art. QT 09: Miscelatore incasso termostatico con deviatore.

Disponibile con braccio a soffitto con codice QT 09 S21

Shower set composed by:

Art. 359SS 348S 30: SQ showerhead in c.p. brass anti-limestone with squared arm in brass cm 30.

Art. 317S 317SQ with **333CN 150:** SQ sliding bar with Q anti-limestone handshower with shower flexible hose in brass cm 150.

Art. 309 S: Lux water punch SQ type.

Art. QT 09: thermostatic built-in mixer with diverter.

Available with ceiling arm with code QT 09 S21



QT 09 S02

Set doccia composto da:

Art. 359SS 348S30: Soffione SQ in ottone anticalcare con braccio quadro in ottone cm 30.

Art. 337S: Supporto doccia deluxe duplex con presa acqua.

Art. 317SQ con **333CN150** con doccetta Q anticalcare e flessibile conico in ottone cromato cm 150.

Art. QT 09: Miscelatore incasso termostatico con deviatore.

Disponibile con braccio a soffitto con il codice QT 09 S22

Shower set composed by:

Art. 359SS 348S30: SQ showerhead in c.p. brass anti-limestone with squared arm in brass cm 30.

Art. 337S: Duplex deluxe shower holder with water punch in c.p. brass.

Art. 317SQ with **333CN150** anti-limestone Q hand shower with shower flexible hose in brass cm 150.

Art. QT 09: thermostatic built-in mixer with diverter.

Available with ceiling arm with code QT 09 S22



QT 09 S03

Set doccia composto da:

Art. 359SS 348S30: Soffione SQ in ottone anticalcare con braccio quadro in ottone cm 30

Art. 339S 317SQ con **333CN 150:** Supporto doccia cromato con doccetta Q anticalcare e flessibile conico in ottone cromato cm 150

Art. 91 QD: Bocca incasso Q con deviatore

Art. QT 09: Miscelatore incasso termostatico con deviatore

Disponibile con braccio a soffitto con codice QT 09 S23

Shower set composed by:

Art. 359SS 348S30: SQ showerhead in c.p. brass anti-limestone with squared arm in brass cm 30

Art. 339S 317SQ with **333CN 150:** c.p. shower holder with anti-limestone Q hand shower with shower flexible hose in brass cm 150

Art. 91 QD: Built-in spout serie Q with diverter

Art. QT 09: thermostatic built-in mixer with diverter

Available with ceiling arm with code QT 09 S23



QT 09 S11

Set doccia composto da:

Art. 330S 359 SS 317SQ 333CN: Colonna doccia a barra quadrata, deluxe, con deviatore e saliscendi, soffione doccia quadrato in ottone con getti in silicone anticalcare, doccetta serie Qubika anticalcare, flessibile doccia conico in ottone.

Art. 330S RA: Supporto quadro per colonna doccia e presa acqua

Art. 91 Q: Bocca incasso vasca/ doccia serie Qubika

Art. QT 09: Miscelatore incasso termostatico con deviatore

Shower set composed by:

Art. 330S 359 SS 317SQ 333CN: Squared bar deluxe shower column, with diverter and sliding part, squared shower head in brass with silicone jets, anti-limestone, Qubika anti-limestone handshower, conical nut flexible hose in brass.

Art. 330S RA: Squared water punch and holder for SQ columns

Art. 91 Q: Built-in spout for bath-shower serie Q

Art. QT 09: thermostatic built-in mixer with diverter



QT 93 7 S01

Set doccia composto da:

Art. 359SS 348S30: Soffione SQ in ottone anticalcare con braccio quadro in ottone cm 30.

Art. 317S 317SQ con 333CN 150: saliscendi Q in ottone cromato con doccetta Q anticalcare e flessibile conico in ottone cromato cm 150.

Art. 309S: Presa acqua Q in ottone cromato.

Art. Q 34 JET: 6 getti anticalcare Q in ottone cromato.

Art. QT 93 7: Miscelatore incasso termostatico con deviatore a tre vie e sette posizioni su piastra unica.

Disponibile con braccio a soffitto con il codice QT 93 7 S21

Shower set composed by:

Art. 359SS 348S30: SQ showerhead in c.p. brass anti-limestone with squared arm in brass cm 30.

Art. 317S317SQ with 333CN 150: Q sliding bar in c.p. brass and anti-limestone Q hand shower with shower flexible hose in brass cm 150

Art. 309S: Deluxe Q water punch, in c.p. brass

Art. Q 34 JET: 6 jets anti-limestone in c.p. brass

Art. QT 93 7: thermostatic built-in mixer with three ways diverter with seven positions on single flange

Available with ceiling arm with code QT 93 7 S21



QT 93 7 S02

Set doccia composto da:

Art. 359SS 348S30: Soffione SQ in ottone anticalcare con braccio quadro in ottone cm 30.

Art. 337 S: Supporto doccia deluxe duplex con presa acqua.

Art. 317SQ con 333CN 150: con doccetta Q anticalcare e flessibile conico in ottone cromato cm 150.

Art. Q 34 JET: 6 getti anticalcare Q in ottone cromato.

Art. QT 93 7: Miscelatore incasso termostatico con deviatore a tre vie e sette posizioni su piastra unica.

Disponibile con braccio a soffitto con il codice QT 93 7 S22

Shower set composed by:

Art. 359SS 348S30: SQ showerhead in c.p. brass anti-limestone with squared arm in brass cm 30

Art. 337S: Duplex deluxe shower holder with water punch in c.p. brass

Art. 317SQ with 333CN 150: anti-limestone Q hand shower with shower flexible hose in brass cm 150

Art. Q 34 JET: 6 jets anti-limestone in c.p. brass

Art. QT 93 7: thermostatic built-in mixer with three ways diverter with seven positions on single flange

Available with ceiling arm with code QT 93 7 S22



QT 93 7 S03

Set doccia composto da:

Art. 359SS 348S30: Soffione SQ in ottone anticalcare con braccio quadro in ottone cm 30.

Art. 337 S: Supporto doccia deluxe duplex con presa acqua.

Art. 317SQ con 333CN 150: con doccetta Q anticalcare e flessibile conico in ottone cromato cm 150.

Art. 91 Q: Bocca incasso serie Q.

Art. QT 93 7: Miscelatore incasso termostatico con deviatore a tre vie e sette posizioni su piastra unica.

Disponibile con braccio a soffitto con il codice QT 93 7 S23

Shower set composed by:

Art. 359SS 348S30: SQ showerhead in c.p. brass anti-limestone with squared arm in brass cm 30.

Art. 337S: Duplex deluxe shower holder with water punch in c.p. brass.

Art. 317SQ with 333CN 150: anti-limestone Q hand shower with shower flexible hose in brass cm 150.

Art. 91 Q: Built-in spout Q serie.

Art. QT 93 7: thermostatic built-in mixer with three ways diverter with seven positions on single flange.

Available with ceiling arm with code QT 93 7 S23



QT 30 S11

Set doccia composto da:

Art. 330S 359 SS 317SQ 333CN: Colonna doccia a barra quadrata, deluxe, con deviatore e saliscendi, soffione doccia quadrato in ottone con getti in silicone anticalcare, doccetta serie Qubika anticalcare, flessibile doccia conico in ottone.

Art. 330SRA: Presa acqua-attacco a muro quadrato.

Art. QT 30: Miscelatore incasso termostatico doccia Qubika.

Shower set composed by:

Art. 330S 359 SS 317SQ 333CN: Squared bar deluxe shower column, with diverter and sliding part, squared shower head in brass with silicone jets, anti-limestone, Qubika anti-limestone handshower, conical nut flexible hose in brass.

Art. 330SRA: Squared water punch and wall connection.

Art. QT 30: thermostatic built-in single-lever shower mixer Qubika.



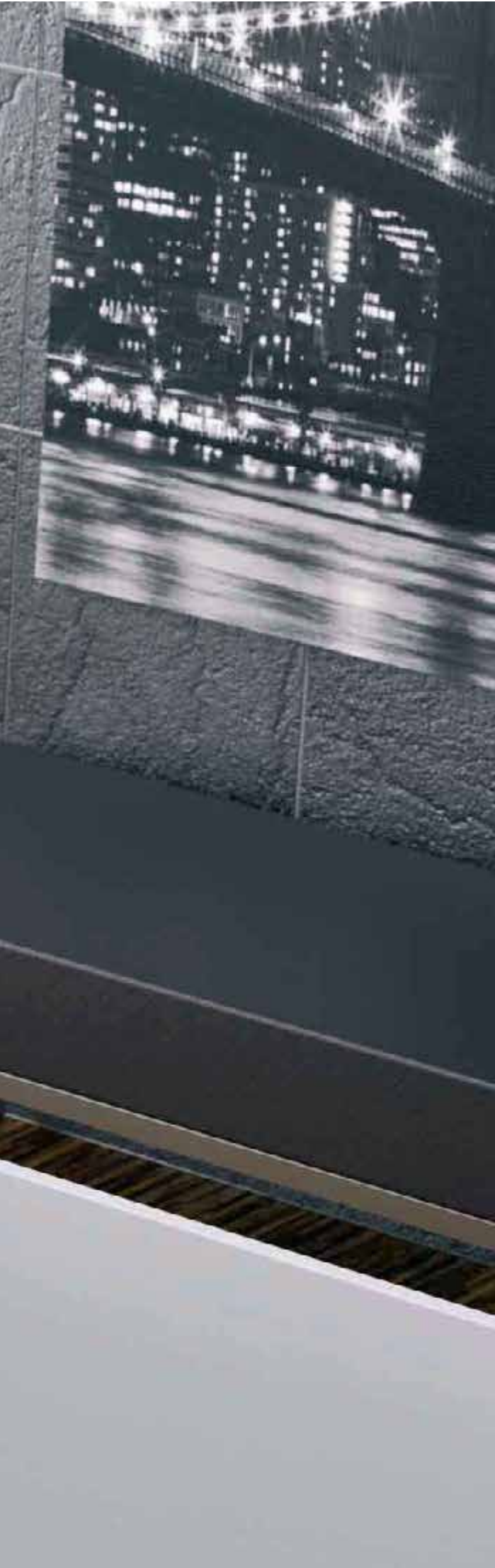

QUBIKA CASCATA

Con la sua forza vitale, la cascata è il simbolo di rigenerazione per eccellenza. Il suo correre ci riporta in luoghi naturali e accompagna la mente in fantasie e rituali di benessere. Qubika Cascata, nata sulle linee di Qubika, ci porta in una nuova condizione di relax nell'uso di oggetti del quotidiano, riequilibrando attraverso la freschezza, il suono e la purezza dell'elemento vitale, l'acqua.

With its vital force, the waterfall is a symbol of regeneration for excellence. Its run takes us back to natural places accompanying the mind in wellness fantasies and rituals.

Qubika Cascata, born on the lines of Qubika, takes us to a new state of relax in the use of everyday objects, rebalancing us through the freshness, the sound and the pureness of the vital element, water.

QUBIKA CASCATA



CARATTERISTICHE TECNICHE:

La serie è dotata di cartuccia a dischi ceramici, Ø 35 mm, prodotta da S.T.S.R. - Studio Tecnico Sviluppo e Ricerche - www.stsr.it.

Finiture disponibili : cromo, bianco opaco, nero opaco.

TECHNICAL CHARACTERISTICS:

The series is equipped with ceramic cartridge, Ø 35 mm, produced by S.T.S.R. - Research Development Technical Office - www.stsr.it.

Available finishes: chrome, matt white, matt black.



QC 10

Miscelatore monocomando per lavabo, con bocca a cascata e scarico.
Single-lever basin mixer with waterfall spout and pop-up waste.

QC 11

Miscelatore monocomando per lavabo, con bocca a cascata, senza scarico.
Single-lever basin mixer with waterfall spout, without pop-up waste.



QC 10 L

Miscelatore monocomando alto per lavabo, con bocca a cascata e scarico click-clack e troppo pieno.

Single-lever basin mixer high neck with waterfall spout, click-clack waste and overflow.

QC 10 L B

Come QC 10 L, con scarico click-clack senza troppo pieno.
As QC 10 L, with click-clack waste without overflow.

QC 11 L

Come QC 10 L, senza scarico.
Means above QC 10 L, without click-clack waste.



QC 15

Miscelatore monocomando a incasso per lavabo, con piastra rettangolare in ottone cromato e bocca a cascata squadrata lunghezza cm 18.

Single lever built-it basin mixer, with rectangular wall flange in chrome plated brass and waterfall squared spout length cm 18.



QC 14

Miscelatore monocomando a incasso per lavabo, con piastra verticale rettangolare in ottone cromato e bocca a cascata squadrata lunghezza cm 18.

Single lever built-it basin mixer, with vertical rectangular wall flange in chrome plated brass and waterfall squared spout length cm 18.

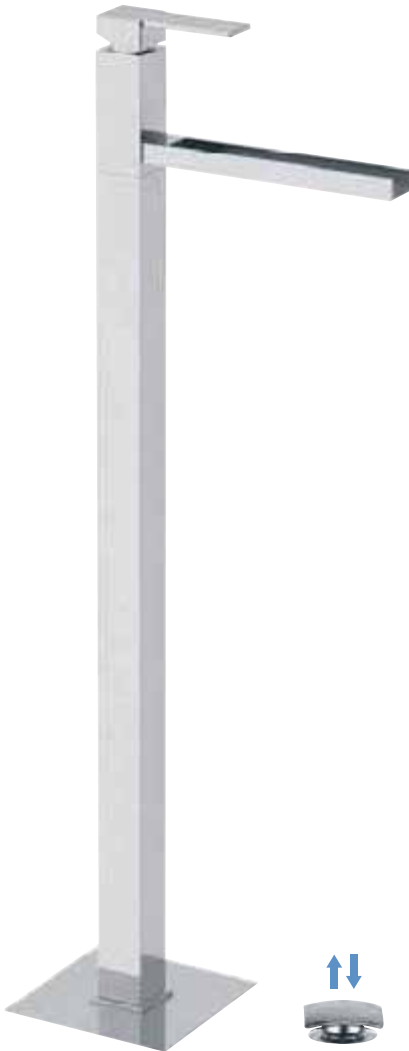

QC 18

Miscelatore monocomando lavabo da pavimento, altezza bocca cm 95, con bocca a cascata, scarico click-clack con troppo pieno.

Single-lever mixer floor mounting, spout height cm 95, with waterfall spout, click-clack waste with overflow.



PATENTED

Q 20

Miscelatore monocomando per bidet, con aeratore direzionabile, tettuccio di protezione e con scarico.

Single-lever bidet mixer with adjustable aerator, covered and shielded and pop-up waste.



PATENTED

Q 21

Come Q 20, senza scarico.

Means above Q 20, without pop-up waste.





QC 02

Miscelatore monocomando per vasca, esterno, con bocca a cascata ed aeratore integrato, con doccia duplex.

Single-lever external bath mixer, with waterfall spout and built-in aerator, with duplex shower.

QC 05

Miscelatore monocomando per vasca, esterno, con bocca a cascata ed aeratore integrato, senza set doccia.

Single-lever external bath mixer, with waterfall spout and built-in aerator, without shower set.



91 ZCA

Bocca bordo vasca getto a cascata.

Spout for deck bath/shower with waterfall jet.



91 ZCF

Bocca bordo vasca con effetto multigetto.

Spout for deck bath/shower with multijets effect.

QC 08

Miscelatore vasca da pavimento, altezza bocca cm 85, con bocca a cascata, deviatore e kit doccia.

Single-lever bath mixer floor mounting, spout height cm 85, with waterfall spout, diverter and shower kit.



91 QC

Bocca incasso a cascata, serie QC.

Built-in spout QC serie, with waterfall effect.



91 ZC

Bocca incasso a cascata, serie ZC.

Built-in spout ZC series, with waterfall effect.



QC 06

Miscelatore monocomando bordo vasca con deviatore, bocca cascata e doccetta in ottone cromato
single lever deck bath/shower mixer with diverter, waterfall spout and c.p. brass hand shower

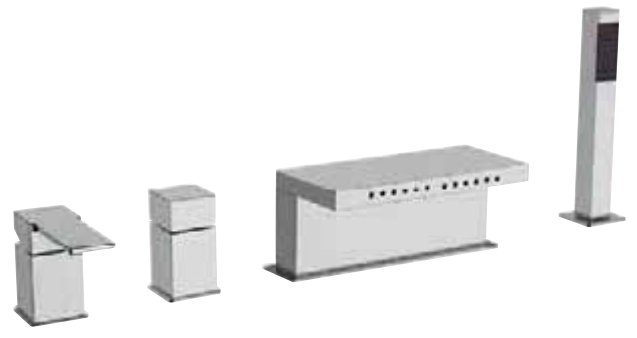

Q 06

Miscelatore monocomando bordo vasca con deviatore, bocca con effetto multigetto e doccetta in ottone cromato.
Single lever deck bath/shower mixer with diverter, spout with multijets effect and c.p. brass hand shower.

QUBIKA CASCATA



QC 93 7 S33

Set doccia composto da:

Art. 359 ZC: Soffione doccia con getto a cascata.

Art. 317SQ 337S: Set doccia duplex anticalcare SQ con presa acqua.

Art. 91 QC: Bocca incasso a cascata serie QC.

Art. Q 93 7: Miscelatore monocomando per doccia con deviatore a tre vie e sette posizioni su unica piastra

Shower set composed by:

Art. 359 ZC: c.p. brass shower head with waterfall jet.

Art. 317SQ 337S: Duplex water punch shower set with SQ, anti-limestone.

Art. 91 QC: Waterfall built-in spout serie QC.

Art. Q 93 7: single lever built-in shower mixer with three ways diverter with seven positions on single flange



QC 94 S34

Set doccia composto da:

Art. 359 ZC: Soffione doccia con getto a cascata.

Art. 317S 317SQ: Saliscendi quadro con doccetta Q anticalcare e flessibile conico in ottone cromato.

Art. 91 QC: Bocca incasso a cascata serie QC.

Art. Q34 JET: 6 getti anticalcare SQ in ottone cromato.

Art. 309 S: Presa acqua lusso quadrata.

Art. Q 94: Miscelatore monocomando per doccia con deviatore a quattro posizioni su unica piastra.

Shower set composed by:

Art. 359 ZC: c.p. brass shower head with waterfall jet.

Art. 91 QC: Waterfall built-in spout serie QC.

Art. 309 S: Lux water punch SQ type.

Art. 317S 317SQ: C.p. brass squared sliding rail with antilimestone SQ handshower and flexible cm 150.

Art. Q34 JET: 6 anti-limestone SQ jets, in cp brass.

Art. Q 94: Single lever built-in shower mixer with four ways diverter



Art. QC 93 7 S03, con soffione anticalcare a pioggia rettangolare completamente in ottone con braccio cm 30, **Art. 359SS 348S30.**

Art. QC 93 7 S03, with anti-limestone rectangular shower head in brass with arm cm 30, **Art. 359SS 348S30.**

Disponibile con braccio a soffitto QC 93 7 S23

Available with ceiling arm QC 93 7 S23



Art. QC 94 S04, con soffione anticalcare a pioggia rettangolare completamente in ottone con braccio cm 30, **Art. 359SS 348S30.**

Art. QC 94 S04, with anti-limestone rectangular shower head in brass with arm cm 30, **Art. 359SS 348S30.**

Disponibile con braccio a soffitto QC 94 S24

Available with ceiling arm QC 94 S24



QC 09 S11

Set doccia composto da:

Art. 330S - 359 SS - 317SQ - 333CN 150: Colonna doccia a barra quadrata, deluxe, con deviatore e saliscendi, soffione doccia quadrato in ottone con getti in silicone anticalcare, doccetta serie Qubika anticalcare, flessibile doccia conico in ottone

Art. 330S RA: Supporto quadro per colonna doccia e presa acqua

Art. 91 QC: Bocca incasso a cascata serie QC.

Art. Q 09: Miscelatore incasso con deviatore

Shower set composed by:

Art. 330S - 359 SS - 317SQ - 333CN 150: Squared bar deluxe shower column, with diverter and sliding part, squared shower head in brass with silicone jets, anti-limestone, Qubika anti-limestone handshower, conical nut flexible hose in brass

Art. 330S RA: Squared water punch and holder for SQ columns

Art. 91 QC: Waterfall built-in spout serie QC.

Art. Q 09: Built-in mixer with diverter



QTC 93 7 S33

Set doccia composto da:

- Art. 359 ZC:** Soffione doccia con getto a cascata.
- Art. 317 SQ 337S:** Set doccia duplex anticalcare SQ con presa acqua.
- Art. 91 QC:** Bocca incasso a cascata serie QC.
- Art. QT 93 7:** Miselatore monocomando termostatico per doccia con deviatore a tre vie e sette posizioni su unica piastra

Shower set composed by:

- Art. 359 ZC:** c.p. brass shower head with waterfall jet.
- Art. 317SQ 337S:** Duplex water punch shower set with SQ handshower, anti-limestone.
- Art. 91 QC:** Waterfall built-in spout serie QC.
- Art. QT 93 7:** Thermostatic single lever built-in shower mixer with three ways diverter with seven positions on single flange



QTC 94 S34

Set doccia composto da:

- Art. 359 ZC:** Soffione doccia con getto a cascata.
- Art. 317S 317SQ:** Saliscendi quadro con doccetta Q anticalcare e flessibile conico in ottone cromato
- Art. 91 QC:** Bocca incasso a cascata serie QC.
- Art. Q34 JET:** 6 getti anticalcare SQ in ottone cromato
- Art. 309 S:** Presa acqua lusso quadrata
- Art. QT 94:** Miselatore monocomando termostatico per doccia con deviatore a quattro vie su unica piastra

Shower set composed by:

- Art. 359 ZC:** c.p. brass shower head with waterfall jet.
- Art. 91 QC:** Waterfall built-in spout serie QC.
- Art. 309 S:** Lux water punch SQ type
- Art. 317S 317SQ:** C.p. brass squared sliding rail with antilimestone SQ handshower and flexible cm 150.
- Art. Q34 JET:** 6 anti-limestone SQ jets, in cp brass.
- Art. QT 94:** Thermostatic single lever built-in shower mixer with four ways diverter on single flange



Art. QTC 93 7 S03, con soffione anticalcare a pioggia rettangolare completamente in ottone con braccio cm 30, Art. 359SS 348S30.

Art. QTC 93 7 S03, with anti-limestone rectangular shower head in brass with arm cm 30, Art. 359SS 348S30.

Disponibile con braccio a soffitto QTC 93 7 S23
Available with ceiling arm QTC 93 7 S23



Art. QTC 94 S04, con soffione anticalcare a pioggia rettangolare completamente in ottone con braccio cm 30, Art. 359SS 348S30.

Art. QTC 94 S04, with anti-limestone rectangular shower head in brass with arm cm 30, Art. 359SS 348S30.

Disponibile con braccio a soffitto QTC 94 S24
Available with ceiling arm QTC 94 S24



QTC 09 S11

Set doccia composto da:

- Art. 330S - 359 SS - 317SQ - 333CN 150:** Colonna doccia a barra quadrata, deluxe, con deviatore e saliscendi, soffione doccia quadrato in ottone con getti in silicone anticalcare, boccetta serie Qubika anticalcare, flessibile doccia conico in ottone
- Art. 330S RA:** Supporto quadro per colonna doccia e presa acqua
- Art. 91 QC:** Bocca incasso a cascata serie QC.
- Art. QT 09:** Miselatore termostatico incasso con deviatore

Shower set composed by:

- Art. 330S - 359 SS - 317SQ - 333CN 150:** Squared bar deluxe shower column, with diverter and sliding part, squared shower head in brass with silicone jets, anti-limestone, Qubika anti-limestone handshower, conical nut flexible hose in brass
- Art. 330S RA:** Squared water punch and holder for SQ columns
- Art. 91 QC:** Waterfall built-in spout serie QC.
- Art. QT 09:** Thermostatic built-in mixer with diverter



S Q 3

La linea SQ3, tramite il gioco armonico di proporzioni sul tema del quadrato, rinnova il desiderio di un minimalismo puro.

Questi miscelatori si presentano eleganti ed importanti, anche grazie al valore dimensionale di base della cartuccia Ø 35.

SQ3 line, through an armonic game of proportions on the squared theme, renew the desire of a pure minimalism.

These mixers look elegant and important, also thanks to the base dimentional value of the Ø 35 mm cartridge.





CARATTERISTICHE TECNICHE:

La serie è dotata di cartuccia a dischi ceramici, Ø 35 mm, prodotta da S.T.S.R. - Studio Tecnico Sviluppo e Ricerche - www.stsr.it.

Finiture disponibili : cromo, bianco opaco, nero opaco.

TECHNICAL CHARACTERISTICS:

The series is equipped with ceramic cartridge, Ø 35 mm, produced by S.T.S.R. - Research Development Technical Office - www.stsr.it.

Available finishes: chrome, matt white, matt black.



S 10 3

Miscelatore monocomando per lavabo, con scarico.
Single-lever basin mixer with pop-up waste.

S 11 3

Miscelatore monocomando per lavabo, senza scarico.
Single-lever basin mixer without pop-up waste.



S 10 L 3

Miscelatore monocomando alto per lavabo, con scarico click-clack e troppo pieno.
Single-lever basin mixer high neck with click-clack waste with overflow.

S 10 L B 3

Come S 10 L 3, con scarico click-clack senza troppo pieno.
As S 10 L 3, with click-clack waste without overflow.

S 11 L 3

Come S 10 L 3, senza scarico.
Means above S 10 L 3, without click-clack waste.

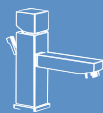

S 14 3

Miscelatore monocomando a incasso per lavabo, con piastra verticale rettangolare in ottone cromato e bocca quadrata lunghezza cm 18.

Single lever built-it basin mixer, with vertical rectangular wall flange in chrome plated brass and squared spout length cm 18.



S 15 3

Miscelatore monocomando a incasso per lavabo, con piastra rettangolare in ottone cromato e bocca quadrata lunghezza cm 18.

Single lever built-it basin mixer, with rectangular wall flange in chrome plated brass and squared spout length cm 18.



PATENTED

S 20 3

Miscelatore monocomando per bidet, con aeratore direzionabile e scarico.

Single-lever bidet mixer with adjustable aerator and pop-up waste.

S 21 3

Come S 20 3, senza scarico.

Means above S 20 3, without pop-up waste.

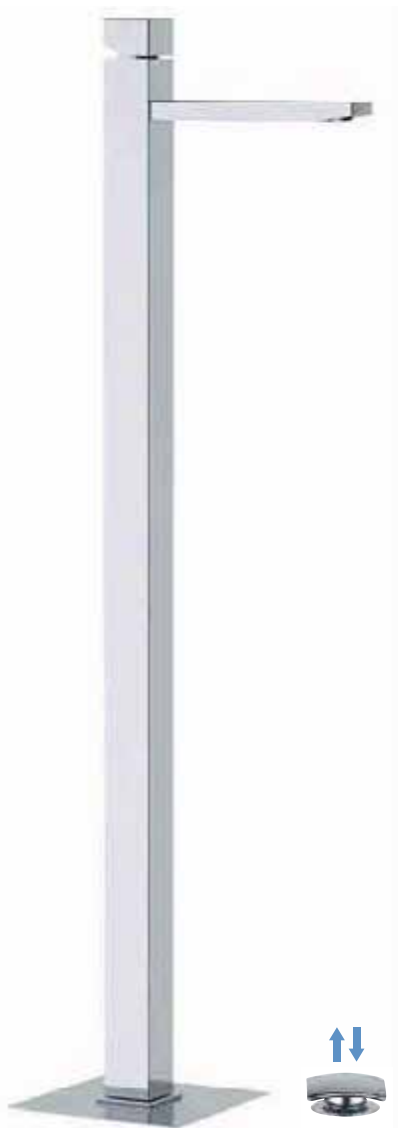

S 18 3

Miscelatore monocomando lavabo da terra, altezza bocca cm 95, con scarico click-clack con troppo pieno.

Single-lever mixer for floor mounting, spout height cm 95, with click-clack waste with overflow.



S 63 3

Miscelatore incasso per shut-off.

Built-in shut-off mixer.



S 60 3

Miscelatore incasso per shut-off comprensivo di: doccetta shut-off art 332RES, supporto doccia- presa acqua su piastra in ottone cromato e flessibile doccia cm 120.

Built-in shut-off mixer set including : shut.off art 332RES, shower holder-water punch on flange, all in c.p. brass and shower flexible cm 120.



S 10 G3

Miscelatore monocomando per lavabo, con canna corta girevole, con scarico click-clack, con troppo pieno.

Single-lever one-hole sink mixer, with short movable spout, with click clack and overflow.



S 10 GL3

Miscelatore monocomando alto per lavabo, con canna corta girevole, con scarico click-clack, con troppo pieno.

High single-lever one-hole sink mixer, with short movable spout, with click clack and overflow.



S 10 GLXL3

Miscelatore monocomando alto per lavabo, con canna lunga a "U" girevole, con scarico click-clack, con troppo pieno.

High single-lever one-hole sink mixer, with long "U" movable spout, with click clack system and overflow.



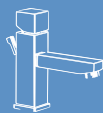

S 02 3

Miscelatore monocomando per vasca, esterno, con doccia duplex.

Single-lever external bath mixer, with duplex shower.

S 05 3

Miscelatore monocomando per vasca, esterno, senza set doccia.

Single-lever bath mixer, without shower set.



S 07 3

Miscelatore monocomando bordo vasca con bocca quadra, deviatore integrato e doccetta quadrata estraibile in ottone cromato.

Single-lever deck bath/shower mixer, with squared spout, diverter, and squared chrome plated brass pull-out handshower.

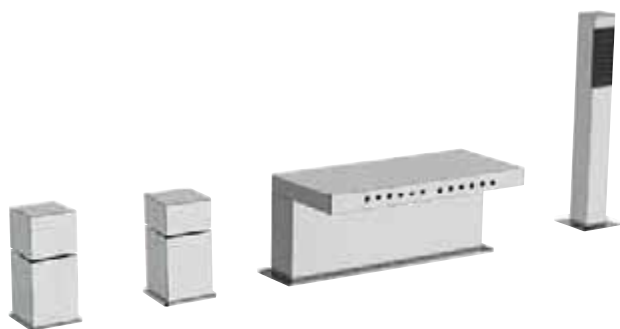

S 06 3

Miscelatore monocomando bordo vasca con deviatore, bocca con effetto multigetto e doccetta in ottone cromato.

Single lever deck bath/shower mixer with diverter, spout with multijets effect and c.p. brass hand shower.



SC 06 3

Miscelatore monocomando bordo vasca con deviatore, bocca cascata e doccetta in ottone cromato

single lever deck bath/shower mixer with diverter, waterfall spout and c.p. brass hand shower



S 04 3

Miscelatore monocomando per vasca da incasso, su piastra rettangolare, con bocca lunga cm 18, deviatore e kit doccia integrato.

Single-lever bath mixer, with rectangular wall flange, spout long cm 18, diverter and integrated shower kit.



S 39 3

Miscelatore monocomando esterno per doccia, con doccia duplex.

Wall mounted single-lever shower mixer, with duplex shower.

S 31 3

Miscelatore monocomando esterno per doccia.

Wall mounted single-lever shower mixer.



91 S

Bocca incasso per miscelatore vasca-doccia, cm 18.
Built-in spout for bath-shower mixer, cm 18.



91 SD

Bocca incasso per miscelatore vasca-doccia, cm 18, con deviatore integrato.
Built-in spout for bath-shower mixer, cm 18, with diverter.



S 30 3

Miscelatore monocomando da incasso senza deviatore per vasca/doccia.
Built-in bath/shower single lever mixer without diverter.



S 09 3

Miscelatore monocomando da incasso con deviatore per vasca/doccia.
Built-in bath/shower single-lever mixer with diverter.



317S 317DS

Saliscendi SQ completamente in ottone con doccetta minimale SQ in abs cromato e flessibile conico in ottone cromato cm 150.

SQ sliding bar completely in c.p. brass, with handshower SQ in c.p. abs and one conical nut shower flexible cm 150.



S 93 7 3

Miscelatore monocomando per doccia, con deviatore a 3 vie e 7 posizioni su piastra unica.

Single-lever shower mixer with 3 ways and 7 positions diverter on single flange.

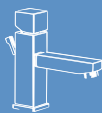

S 09 3 S02

Set doccia composto da:

Art. 359SS 348S30: Soffione SQ in ottone anticalcare con braccio quadro in ottone cm 30

Art. 337S: Supporto doccia deluxe duplex con presa acqua in ottone cromato

Art. 317SS con 333CN150: con doccetta Q anticalcare e flessibile conico in ottone cromato cm 150

Art. S 09 3: Miscelatore incasso con deviatore

Shower set composed by:

Art. 359SS 348S30: SQ showerhead in c.p. brass anti-limestone with squared arm in brass cm 30

Art. 337 S: Duplex deluxe shower holder with water punch in c.p. brass

Art. 317SS with 333CN150: anti-limestone Q hand shower with shower flexible hose in brass cm 150

Art. S 09 3: Built-in mixer with diverter



S 93 7 3 S01

Set doccia composto da:

Art. 359SS 348S30: Soffione SQ in ottone anticalcare con braccio quadro in ottone cm 30

Art. 317S 317SS: Saliscendi quadro con doccetta SQ in ottone e flessibile conico in ottone cromato.

Art. 309S: Presa acqua Q in ottone cromato

Art. Q 34 JET: 6 getti anticalcare Q in ottone cromato

Art. S 93 7 3: Miscelatore incasso con deviatore a tre vie e sette posizioni su piastra unica

Shower set composed by:

Art. 359SS 348S30: SQ showerhead in c.p. brass anti-limestone with squared arm in brass cm 30

Art. 317S 317SS: SQ sliding bar in c.p. brass, with handshower SQ in c.p. abs and one conical nut shower flexible

Art. 309 S: Deluxe Q water punch, in c.p. brass

Art. Q 34 JET: 6 jets anti-limestone in c.p. brass

Art. S 93 7 3: Built-in mixer with three ways diverter with seven positions on single flange



S 93 7 3 S02

Set doccia composto da:

Art. 359SS 348S 30: Soffione SQ in ottone anticalcare con braccio quadro in ottone cm 30

Art. 337 S: Supporto doccia deluxe duplex con presa acqua.

Art. 317SS con 333CN 150: con doccetta in ottone S anticalcare e flessibile conico in ottone cromato cm 150

Art. Q 34 JET: 6 getti anticalcare Q in ottone cromato

Art. S 93 7 3: Miscelatore incasso con deviatore a tre vie e sette posizioni su piastra unica

Shower set composed by:

Art. 359SS 348S30: SQ showerhead in c.p. brass anti-limestone with squared arm in brass cm 30

Art. 337S: Duplex deluxe shower holder with water punch in c.p. brass

Art. 317SS with 333CN 150: anti-limestone brass S hand shower with shower flexible hose in brass cm 150

Art. Q 34 JET: 6 jets anti-limestone in c.p. brass

Art. S 93 7 3: Built-in mixer with three ways diverter with seven positions on single flange



S 93 7 3 S03

Set doccia composto da:

Art. 359SS 348S 30: Soffione SQ in ottone anticalcare con braccio quadro in ottone cm 30

Art. 337 S: Supporto doccia deluxe duplex con presa acqua.

Art. 317SS con 333CN 150: con doccetta in ottone S anticalcare e flessibile conico in ottone cromato cm 150

Art. 91 S : Bocca incasso serie S

Art. S 93 7 3: Miscelatore incasso con deviatore a tre vie e sette posizioni su piastra unica

Shower set composed by:

Art. 359SS 348S30: SQ showerhead in c.p. brass anti-limestone with squared arm in brass cm 30

Art. 337 S: Duplex deluxe shower holder with water punch in c.p. brass

Art. 317SS with 333CN 150: anti-limestone brass S hand shower with shower flexible hose in brass cm 150

Art. 91 S : Built-in spout S serie

Art. S 93 7 3: Built-in mixer with three ways diverter with seven positions on single flange



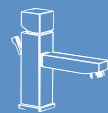

S 40 3

Miscelatore monocomando per lavello, corpo quadrato e completamente girevole.

Single lever one-hole squared sink mixer with entirely movable body.



S 42 U 3

Miscelatore monocomando per lavello, con bocca alta a "U" girevole.

Single lever one-hole squared sink mixer with high "U" movable spout.



S 41 3

Miscelatore monocomando esterno per lavello a muro con bocca girevole squadrata.

Single-lever wall mounted sink mixer, with movable squared spout.



MINIMAL

Elegante e raffinata, la linea Minimal si pone come icona del nuovo millennio in termini di modernità estetica e costruttiva.

L'interpretazione modello di forme completamente arrotondate viene interrotta dal taglio obliquo della bocca di erogazione e dal particolare della maniglia che, piegandosi leggermente all'insù, ci porta a visioni di rinnovata positività. Questa rubinetteria si posiziona sicuramente tra i classici del moderno.

Elegant and refined, the Minimal line stands as an icon of the new millennium in terms of aesthetical and constructive modernity.

The model interpretation of fully rounded forms is interrupted by the oblique cut of the spout and by the handle particular that, slightly bending upward, brings us a renewed vision of positivity. This taps series is indeed positioned between the classics of modern.



CARATTERISTICHE TECNICHE:

La serie è dotata di cartuccia a dischi ceramici, Ø 35 mm, prodotta da S.T.S.R. - Studio Tecnico Sviluppo e Ricerche - www.stsr.it

Finiture disponibili : cromo, bianco opaco, nero opaco, satinato.

TECHNICAL CHARACTERISTICS:

The series is equipped with ceramic cartridge, Ø 35 mm, produced by S.T.S.R. - Research Development Technical Office - www.stsr.it

Available finishes: chrome, matt white, matt black, satin.



N 10 L

Miscelatore monocomando alto per lavabo, su colonna, altezza bocca mm 200 lunghezza bocca mm 110, con scarico.

Single-lever basin mixer, high neck, height of spout mm 200, length of spout mm 110, with pop-up waste.

N 10 L B

Come N 10 L, con scarico click-clack senza troppo pieno.

As N 10 L, with click-clack waste without overflow.

N 11 L

Come N 10 L, senza scarico.

As N 10 L, without click-clack waste.



N 10 LXL

Miscelatore monocomando per lavabo, su colonna, altezza bocca mm 250, lunghezza bocca mm 180, con scarico.

Single-lever basin mixer, high neck, height of spout mm 250, length of spout mm 180, with pop-up waste.

N 10 LXL B

Come N 10 LXL, con scarico click-clack senza troppo pieno.

As N 10 LXL, with click-clack waste without overflow.

N 11 LXL

Come N 10 LXL, senza scarico.

As N 10 LXL, without click-clack waste.



N 15

Miscelatore monocomando a incasso per lavabo serie Minimal, con piastra rettangolare in ottone cromato e bocca minimal cm 18.

Single lever built-it basin mixer serie Minimal, with rectangular wall flange in chrome plated brass and minimal spout length cm 18.



N 14

Miscelatore monocomando a incasso per lavabo serie Minimal, con piastra verticale rettangolare in ottone cromato e bocca minimal cm 18.

Single lever built-it basin mixer serie Minimal, with vertical rectangular wall flange in chrome plated brass and minimal spout length cm 18.



N 18

Miscelatore monocomando lavabo da terra, altezza bocca cm 95, con scarico click-clack con troppo pieno.

Single-lever mixer for floor mounting, spout height cm 95, with click-clack waste with overflow.



N 10

Miscelatore monocomando per lavabo, con scarico.

Single-lever basin mixer with pop-up waste.

N 11

Miscelatore monocomando per lavabo, senza scarico.

Single-lever basin mixer without pop-up waste.



N 10 A

Miscelatore monocomando per lavabo, altezza bocca mm 120, lunghezza bocca mm 125, con scarico.

Single-lever basin mixer, height of spout mm 120, length of spout mm 125, with pop-up waste.

N 11 A

Miscelatore monocomando per lavabo, altezza bocca mm 120, lunghezza bocca mm 125, senza scarico.

Single-lever basin mixer, height of spout mm 120, length of spout mm 125, without pop-up waste.







MINIMAL



N 20

Miscelatore monocomando per bidet, con aeratore direzionabile e scarico.

Single-lever bidet mixer with adjustable aerator and pop-up waste.

N 21

Come N 20, senza scarico.

As N 20, without pop-up waste.



N 63

Miscelatore incasso per shut-off.
Built-in shut-off mixer.



N 23

Miscelatore monocomando per bidet, con doccetta.

Single-lever bidet mixer with spray.



N 24

Miscelatore monocomando per bidet, con deviatore e doccetta.

Single-lever bidet mixer with diverter and spray.



91 NCF

Bocca bordo vasca con effetto multigetto ed angoli arrotondati.
Spout for deck bath/shower multijets effect and rounded corners.



91 NC

Bocca incasso cascata con bordi arrotondati.
Cascate built-in spout with rounded corners.

359 NC

Soffione doccia con getto a cascata bordi arrotondati.
C.p. brass shower head with rounded corners. and waterfall jet.



N 03

Miscelatore monocomando lavabo/vasca, con deviatore integrato e kit doccia.

Single lever basin/bath mixer with diverter and shower kit.



N 60

Miscelatore incasso per shut-off comprensivo di: doccetta shut-off art 332 OL, supporto doccia- presa acqua su piastra in ottone cromato e flessibile doccia cm 120.

Built-in shut-off mixer set including : shut.off art 332 OL, shower holder water punch on flange, all in c.p. brass and shower flexible cm 120.



91 M

Bocca incasso per miscelatore vasca-doccia, cm 18.
Built-in spout for bath-shower mixer, cm 18.



91 MD

Bocca incasso per miscelatore vasca-doccia, con deviatore integrato, cm 18.
Built-in spout for bath-shower mixer, with diverter, cm 18.



N 02

Miscelatore monocomando per vasca, esterno, con doccia duplex.
Wall mounted single-lever bath mixer with duplex shower.

N 05

Miscelatore monocomando per vasca, esterno, senza doccia.
Wall mounted single-lever bath mixer without shower.



N 07

Miscelatore monocomando bordo vasca serie Minimal con deviatore a molla, bocca minimale e doccetta minimale in ottone cromato.

Single lever deck bath/shower mixer serie Minimal with spring diverter, with minimal spout and minimal chrome plated brass hand shower.



N 08

Miscelatore vasca da pavimento, altezza bocca cm 85, con deviatore e kit doccia.

Single-lever bath mixer floor mounting, spout height cm 85, with diverter and shower kit.



N 06 2

Miscelatore monocomando bordo vasca con deviatore, bocca con effetto multigetto e doccetta in ottone cromato.

Single lever deck bath/shower mixer with diverter, spout with multijets effect and c.p. brass hand shower.



N 27

Miscelatore bordo vasca con deviatore e doccetta minimale.

Single lever bath deck mixer with diverter and minimal shower head.



N 04

Miscelatore monocomando a incasso per vasca, su piastra rettangolare, con bocca lunga cm 18, deviatore e kit doccia integrato.

Single-lever built-in bath mixer, with rectangular wall flange, spout long 18 cm with diverter and integrated shower kit.









MINIMAL



N 30

Miscelatore monocomando incasso per doccia.

Single lever built-in shower mixer.



N 09

Miscelatore monocomando incasso con deviatore per vasca/doccia.

Single lever built-in bath/shower mixer with diverter.



N 30 L

Miscelatore monocomando incasso per doccia, con piastra lusso.

Single lever built-in shower mixer, with deluxe flange.



N 09 L

Miscelatore monocomando incasso con deviatore per vasca/doccia, con piastra lusso.

Single lever built-in bath/shower mixer with diverter, with deluxe flange.



N 92

Miscelatore monocomando a incasso per doccia, con deviatore a due posizioni (due uscite ed una entrata) su piastra unica.

Single-lever built-in shower mixer with 2 positions diverter (2 outlets and 1 inlet) on single flange.



N 93

Miscelatore monocomando per doccia con deviatore a tre vie (una entrata e tre uscite) su unica piastra.

Single lever built-in shower mixer with three ways diverter (1 inlet and 3 outlets) on single flange.

N 93 7

Miscelatore monocomando per doccia con deviatore a tre vie e sette posizioni (una entrata, tre uscite e sette posizioni con cui selezionare uscite singole o miscelate tra loro) su unica piastra.

Scatti della maniglia-deviatore:

- lo scatto 1 aziona l'acqua dell'uscita 1
- lo scatto 2 aziona l'acqua dell'uscita 2
- lo scatto 3 aziona l'acqua dell'uscita 3
- lo scatto 4 aziona l'acqua dell'uscita 1
- lo scatto 5 aziona l'acqua delle uscite 1 + 2
- lo scatto 6 aziona l'acqua delle uscite 1 + 2 + 3
- lo scatto 7 aziona l'acqua delle uscite 2 + 3

Single lever built-in shower mixer with three ways diverter seven positions (1 inlet, 3 outlets and seven positions to select single or mixed outlets) on single flange.

Handle steps of the diverter :

- 1st step to run water from outlet 1
- 2nd step to run water from outlet 2
- 3rd step to run water from outlet 3
- 4th step to run water from outlet 1
- 5th step to run water from outlets 1 + 2
- 6th step to run water from outlets 1 + 2 + 3
- 7th step to run water from outlets 2 + 3



N 94

Miscelatore monocomando per doccia, con deviatore a 4 posizioni (4 uscite ed 1 entrata) su piastra unica.

Single-lever shower mixer with 4 positions diverter (4 outlets and 1 inlet,) on single flange.

N 95

Miscelatore monocomando per doccia, con deviatore a 5 posizioni (5 uscite ed una entrata) su piastra unica.

Single-lever shower mixer with 5 positions diverter (5 outlets and 1 inlet,) on single flange.



N 95 C

Miscelatore monocomando per doccia, con deviatore a 5 posizioni (5 uscite ed una entrata) su doppia piastra, con possibilità di chiusura del flusso dal deviatore durante il cambio di posizione (col vantaggio di non azionare posizioni non desiderate e non dover toccare la maniglia che seleziona anche la temperatura).

Single-lever shower mixer with 5 positions diverter (5 outlets and 1 inlet) on double flange, with the possibility of closing the flow from the diverter during the position change (with the advantage of not starting the undesired positions and also not be forced to touch the handle that also selects the temperature).

N 94 C

Come N 95 C, con deviatore a quattro posizioni.

Same as N 95 C, with 4 positions diverter.



331 N1

Colonna saliscendi free-standing in ottone cromato con attacco da pavimento per doccia, spa, piscina etc; forma minimale rotonda, con comando monoacqua, deviatore, doccetta in ottone cromato e flessibile doccia cm 200, soffione anticalcare in ottone cromato Ø cm 30.

Free-standing chrome plated brass column with floor mounted water control for shower, spa, swimming pools, ecc; round minimal shape, with diverter and sliding bar, with c.p. brass handshower and flexible cm 200, c.p. brass anti-limestone shower head Ø 30 cm.

331 N51

Colonna free-standing in ottone cromato con attacco da pavimento per doccia, spa, piscina etc, forma minimale rotonda, con comando monoacqua e soffione anticalcare in ottone cromato Ø cm 30.

Free-standing chrome plated brass column with floor mounted water control for shower, spa, swimming pools, etc; round minimal shape, with c.p. brass anti-limestone shower head Ø 30 cm.



331 N2

Colonna con miscelatore acqua calda-fredda saliscendi free-standing con attacco da pavimento, tutta in ottone cromato per doccia, spa, piscina etc, forma minimale rotonda, con deviatore, doccetta in ottone cromato e flessibile doccia cm 200, soffione anticalcare in ottone cromato Ø cm 30.

Free-standing chrome plated brass column with single lever mixer hot/cold floor mounted water control for shower, spa, swimming pools, round minimal shape, with diverter and sliding bar, with c.p. brass handshower with flexible cm 200 and c.p. brass anti-limestone shower head Ø 30 cm.

331 N52

Colonna free-standing con miscelatore acqua calda-fredda, con attacco da pavimento tutta in ottone cromato per doccia, spa, piscina etc, forma minimale rotonda con soffione anticalcare in ottone cromato Ø cm 30.

Free-standing chrome plated brass column with single lever mixer hot/cold floor mounted water control for shower, spa, swimming pools, round minimal shape, with c.p. brass anti-limestone shower head Ø 30 cm.



317M 317DM

Saliscendi minimale con doccetta anticalcare.

Minimal sliding rail set with anti-limestone handshower.



N 31

Miscelatore monocomando esterno per doccia, senza doccia.

Wall mounted single-lever shower mixer, without shower.



N 35

Gruppo doccia a muro, con deviatore integrato ed attacco alto per colonna da 3/4.

Wall mounted shower mixer, with integrated diverter and 3/4 upper connection.



N 39

Miscelatore monocomando esterno per doccia, con doccia duplex.

Wall mounted single-lever shower mixer, with duplex shower.



N 37

Miscelatore esterno doccia con deviatore integrato e colonna deluxe saliscendi girevole, completa di soffione anticalcare, doccetta in Abs cromato e flessibile in ottone.

Wall-mounted single lever shower mixer with incorporated diverter, with swivable deluxe sliding column, complete with anti-limestone showerhead, Abs minimal handshower and brass flexible hose.



N 37 XL

Miscelatore esterno doccia con deviatore integrato e colonna deluxe saliscendi girevole, completa di soffione XL ultrapiatto in ottone anticalcare, doccetta in Abs cromato e flessibile in ottone.

Wall-mounted single lever shower mixer with incorporated diverter, with swivable deluxe sliding column, complete with XL ultra flat anti-limestone C.P. brass showerhead, Abs minimal handshower and brass flexible hose.



N 37 B

Miscelatore esterno doccia con deviatore integrato e colonna minimal saliscendi girevole, completa di soffione e doccetta anticalcare in Abs cromato Ø 20 cm e flessibile in ottone.

Wall-mounted single lever shower mixer with incorporated diverter, with swivable deluxe sliding column, complete with Abs anti-limestone showerhead Ø 20 cm, Abs minimal handshower and brass flexible hose.



N 37 B XL

Miscelatore esterno doccia con deviatore integrato e colonna minimal saliscendi girevole, completa di soffione XL e doccetta anticalcare in Abs cromato Ø 25 cm e flessibile in ottone.

Wall-mounted single lever shower mixer with incorporated diverter, with swivable deluxe sliding column, complete with XL Abs anti-limestone showerhead Ø 25 cm, Abs minimal handshower and brass flexible hose.

MINIMAL WELLNESS



N 09 S01

Set doccia composto da:

Art. 356LU 348N 30: Soffione minimale anticalcare con braccio in ottone cm 30.

Art. 317M 317DM con 333CN 150: Saliscendi minimale con doccetta anticalcare e flessibile conico in ottone cromato.

Art. 309 L: presa acqua tipo rotondo pesante.

Art. N 09 L: Miscelatore incasso con deviatore e piastra lusso.

Shower set composed by:

Art. 356LU 348N 30: Minimal anti-limestone showerhead with arm in brass cm 30.

Art. 317M 317DM with 333CN 150: Minimal sliding bar with anti-limestone handshower and with shower flexible hose in brass cm 150.

Art. 309 L: C.p. brass wall connector, round heavy type

Art. N 09 L: Built-in mixer with diverter and deluxe flange.



N 09 S02

Set doccia composto da:

Art. 356LU 348N 30: Soffione minimale anticalcare con braccio in ottone cm 30.

Art. 337M 317DM con 333CN 150: Doccia duplex minimale anticalcare con supporto presa acqua e flessibile conico in ottone cromato cm 150.

Art. N 09 L: Miscelatore incasso con deviatore e piastra lusso.

Shower set composed by:

Art. 356LU 348N 30: Minimal anti-limestone showerhead with arm in brass cm 30.

Art. 337M 317DM with 333CN 150: Duplex water punch with minimal anti-limestone handshower with shower flexible hose in brass cm 150.

Art. N 09 L: Built-in mixer with diverter and deluxe flange.



N 09 S03

Set doccia composto da:

Art. 356LU 348N 30: Soffione minimale anticalcare con braccio in ottone cm 30.

Art. 339N 317DM con 333CN 150: Doccia duplex minimale anticalcare con supporto duplex e flessibile conico in ottone cromato cm 150.

Art. 91 MD: Bocca incasso Minimal con deviatore integrato.

Art. N 09 L: Miscelatore incasso con deviatore e piastra lusso

Shower set composed by:

Art. 356LU 348N 30: Minimal anti-limestone showerhead with arm in brass cm 30

Art. 339N 317DM with 333CN 150: Minimal anti-limestone handshower with shower flexible hose in brass cm 150 and duplex shower holder

Art. 91 MD: Minimal built-in spout with diverter.

Art. N 09 L: Built-in mixer with diverter with deluxe flange.



N 09 S11

Set doccia composto da:

Art. 330U 356LU 317DM 330RA con 333CN 150: Colonna doccia deluxe girevole con deviatore e saliscendi, completa di soffione doccia cromato anticalcare, doccetta minimale, flessibile doccia e supporto presa acqua per colonna.

Art. N 09 L: Miscelatore monocomando incasso con deviatore e piastra lusso.

Art. 91M: Bocca incasso Minimale.

Shower set composed by:

Art. 330U 356LU 317DM 330RA with 333CN 150: Swivable deluxe shower column with diverter and sliding rail, with anti-limestone showerhead and handshower, flexible in c.p. brass cm 150 and water punch-support for columns.

Art. N 09 L: Single-lever built-in shower mixer with diverter and deluxe flange.

Art. 91M: Minimal built-in spout.



N 93 7 S01

Set doccia composto da:

Art. 359MM30 348N 30: soffione minimale anticalcare in ottone Ø 30, con braccio in ottone cm 30.

Art. 337M 321HG con 333CN 150: Doccia minimale a 2 funzioni, con getti in silicone, supporto doccia duplex in ottone cromato con presa acqua e flessibile conico in ottone cromato cm 150.

Art. N 34 JET: 6 getti minimali anticalcare in ottone cromato.

Art. N 93 7: miscelatore monocomando per doccia con deviatore a tre vie e sette posizioni su unica piastra.

Shower set composed by:

Art. 359MM30 348N 30: Minimal anti-limestone shower head in c.p. brass Ø 30 cm with arm in brass cm 30.

Art. 337M 321HG with 333CN 150: water-punch in c.p. brass with duplex holder, minimal handshower, 2 functions, with silicon jets, with shower flexible hose in brass cm 150.

Art. N 34 JET: 6 Minimal jets anti-limestone in c.p. brass

Art. N 93 7: single lever built-in shower mixer with three ways diverter with seven position on single flange.



N 93 7 S02

Set doccia composto da:

Art. 359MM30 348N 30: soffione minimale anticalcare in ottone Ø 30, con braccio in ottone cm 30.

Art. 317G 321HG con 333CN 150: Saliscendi in ottone cromato e doccetta minimale a 2 funzioni con getti in silicone e flessibile conico in ottone cromato cm 150.

Art. 309 L: presa acqua tipo rotondo pesante.

Art. N 34 JET: 6 getti minimali anticalcare in ottone cromato.

Art. N 93 7: miscelatore monocomando per doccia con deviatore a tre vie e sette posizioni su unica piastra.

Shower set composed by:

Art. 359MM30 348N 30: Minimal anti-limestone shower head in c.p. brass Ø 30 cm with arm in brass cm 30.

Art 317G 321HG with 333CN 150: Minimal c.p. brass sliding bar with handshower 2 functions with silicon jets and with flexible hose in brass cm 150.

Art. 309 L: C.p. brass wall connector, round heavy type

Art. N 34 JET: 6 Minimal jets anti-limestone in c.p. brass.

Art. N 93 7: single lever built-in shower mixer with three ways diverter with seven position on single flange.



N 93 7 S03

Set doccia composto da:

Art. 359MM30 348N 30: soffione minimale anticalcare in ottone Ø 30, con braccio in ottone cm 30.

Art. 337M 321HG con 333CN 150: Doccia minimale a 2 funzioni, con getti in silicone, supporto doccia duplex in ottone cromato con presa acqua e flessibile conico in ottone cromato cm 150.

Art. 91 M: bocca incasso minimale.

Art. N 93 7: miscelatore monocomando per doccia con deviatore a tre vie e sette posizioni su unica piastra.

Shower set composed by:

Art. 359MM30 348N 30: Minimal anti-limestone shower head in c.p. brass Ø 30 cm with arm in brass cm 30.

Art. 337M 321HG with 333CN 150: water-punch in c.p. brass with duplex holder, minimal handshower, 2 functions, with silicon jets, with shower flexible hose in brass cm 150.

Art. 91 M: built-in minimal spout.

Art. N 93 7: single lever built-in shower mixer with three ways diverter with seven position on single flange.



N 30 S12

Sistema doccia completo deluxe composto da:

Art. N 30 L: miscelatore incasso doccia con piastra deluxe

Art. 330U 359MM30 321HG 330RA con 333CN 150: Colonna doccia deluxe girevole con deviatore e saliscendi, completa di soffione doccia cromato anticalcare e doccetta minimale a 2 funzioni con getti in silicone e supporto presa acqua per colonna.

Complete deluxe shower system composed by:

Art. N 30 L: built-in shower mixer with deluxe flange

Art. 330U 359MM30 321HG 330RA con 333CN 150: Adjustable Deluxe shower column with diverter and sliding rail, with c.p. anti-limestone showerhead and minimal handshower, 2 functions, with silicon jets and water punch-support for columns.





N 40

Miscelatore monocomando per lavello, con bocca girevole, altezza bocca mm 160, lunghezza bocca mm 200.

Single-lever one-hole sink mixer, with movable spout, height of spout mm 160, length of spout mm 200.



N 40 L

Come N 40 con altezza bocca mm 280

Means above N 40, with height of spout mm 280.



N 47

Miscelatore monocomando per lavello, con bocca estraibile.

Single-lever one-hole sink mixer, with pull-out spray jet shower.



N 41

Miscelatore monocomando per lavello a muro, con bocca girevole.

Single-lever wall mounted sink mixer, with movable spout.



N 48 319 MO

Miscelatore monocomando bordo lavello serie Minimal con deviatore, bocca minimale e doccetta cromata minimale a 2 funzioni con getti in silicone, idromassaggio ed anticalcare.

Single lever deck sink mixer serie Minimal with diverter, with C.p. minimal handshower 2 functions hydromassage, anti-limestone with silicone jets.



N 48 332 EU

Miscelatore monocomando bordo lavello serie Minimal con deviatore, bocca minimale e doccetta a pulsante minimale in Abs cromata con impugnatura liscia 1/2".

Single lever deck sink mixer serie Minimal with diverter, with C.p. Abs minimal shut-off, with plain handgrip 1/2".





MINIMAL COLOR

La Minimal Color è realizzata per arricchire l'ambiente bagno di elementi con valore rigenerante.

La Cromoterapia è un metodo antichissimo usato per ristabilire equilibri fisici ed emozionali tramite l'uso e l'irradiazione del colore. Seguendo questa ricerca, presentiamo i nostri miscelatori per la Cromoterapia come elementi che entrano nel quotidiano con semplicità grazie a nuove tecnologie che permettono di generare energia direttamente e continuamente tramite il flusso d'acqua in uscita dal miscelatore. La luce bianca o multi-colore fuoriesce quindi come per magia dalle bocche di erogazione senza la necessità di impianti elettrici o di allacciamenti alla corrente.

La cartuccia interna è dotata di una turbina e di un sensore della temperatura. Una terapia naturale ad energia pulita.

Minimal Color is designed to enrich the bathroom of elements with a regenerating value.

The Color Therapy is an ancient method used to restore physical and emotional balance through the use and irradiation of the color. Following this research, we introduce our Color Therapy mixers as elements that come in everyday life with simplicity thanks to new technologies that are able to generate energy directly and continuously by the water flow coming out from the mixer itself. The multi-color or white light comes out by magic from the spouts without the need for any electrical connections or electricity.

The internal cartridge is equipped with a turbine and a temperature sensor. A natural therapy with clean energy.

MINIMAL COLOR



CARATTERISTICHE TECNICHE:

La cartuccia Color è prodotta in Italia da S.T.S.R., certificata CE ed interamente a norma.

Tutte le parti elettriche ed elettroniche sono perfettamente isolate dall'acqua garantendo un perfetto funzionamento a lungo termine. La cartuccia è dotata anche di filtro in entrata che permette alla turbina di lavorare isolata dalle impurità presenti nell'acqua ed alla cartuccia di essere pulita tipo un normale aeratore.

L'intensità della luce non dipende dalla pressione dell'acqua e la cartuccia Color si aziona a 2.5lt/min

Il prodotto è disponibile in quattro varianti denominate A, B, C, D, di seguito dettagliate. Per evidenziare la Vostra scelta, aggiungere la lettera corrispondente a fine codice articolo.

The product is available in four variants named A, B, C, D, that we detail here following. To highlight your selection please add the choosen letter at the end of the article number.

TECHNICAL CHARACTERISTICS:

The Color cartridge is produced in Italy by S.T.S.R. and certified CE.

All the electrical and electronical parts are perfectly isolated from water guaranteeing a long term perfect performance. The cartridge is equipped with an inlet filter that prevent any dirt to get into the turbine, the cartridge can be cleaned likely a normal aerator.

The color intensity does not depend on water pressure and the colorthrapy cartridge starts performing at 2.5lt/m.

A



La luce emanata è solo bianca
The light emitted is white only

B



La luce emanata cambia colore al variare della temperatura

Azzurro: fino a 32°
Bianco : da 32° a 38°
Rosa: oltre 38°

The light emitted changes color with temperature

Light Blue : up to 32°
White: from 32° to 38°
Pink: from 38°



C



La luce emanata cambia colore al variare della temperatura

Blu : fino a 28°
Verde : da 28° a 33°
Giallo: da 33° a 38°
Rosso: da 38°

The light emitted changes color with temperature

Blue : up to 28°
Green: from 28° to 33°
Yellow: from 33° to 38°
Red: from 38°





D



Un arcobaleno di colori e sfumature si alternano creando un continuo gioco emozionale

A rainbow of colors and shades alternate, creating a constant emotional game



NR 10 LXL 2

Miscelatore monocomando per lavabo con cartuccia con luce a led, su colonna, altezza bocca mm 220, lunghezza bocca mm 110, con scarico click-clack con troppo pieno.

Single-lever basin mixer with led light cartridge, high neck, height of spout mm 220, length of spout mm 110, with click-clack waste with overflow.

NR 10 LXL B 2

Come NR 10 LXL 2, con scarico click-clack senza troppo pieno.

As NR 10 LXL 2, with click-clack waste without overflow.

NR 11 LXL 2

Come NR 10 LXL 2, senza scarico.

As NR 10 LXL 2, without click-clack waste.



NR 10 L 2

Miscelatore monocomando alto per lavabo con cartuccia con luce a led, su colonna, altezza bocca mm 180 lunghezza bocca mm 110, con scarico click-clack con troppo pieno.

Single-lever basin mixer, high neck with led light cartridge, height of spout mm 180, length of spout mm 110, with click-clack waste with overflow.

NR 10 L B 2

Come NR 10 L 2, con scarico click-clack senza troppo pieno.

As N 10 L 2, with click-clack waste without overflow.

NR 11 L 2

Come NR 10 L 2, senza scarico.

As NR 10 L 2, without click-clack waste.



NR 10 2

Miscelatore monocomando per lavabo con cartuccia con luce a led, con scarico.

Single-lever basin mixer with led light cartridge and pop-up waste.



NR 11 2

Miscelatore monocomando per lavabo con cartuccia con luce a led, senza scarico.

Single-lever basin mixer with led light cartridge, without pop-up waste.



NR 18 2

Miscelatore monocomando lavabo da terra con cartuccia con luce a led, altezza bocca cm 95, con scarico click-clack e troppo pieno.

Single-lever mixer for floor mounting with led light cartridge, spout height cm 95, with click-clack waste and overflow.



PATENTED

NR 20 2

Miscelatore monocomando per bidet, con aeratore direzionabile, cartuccia con luce a led e con scarico.

Single-lever bidet mixer with led light cartridge, adjustable aerator and pop-up waste.



PATENTED

NR 21 2

Miscelatore monocomando per bidet, con aeratore direzionabile, cartuccia con luce a led, senza scarico.

Single-lever bidet mixer with led light cartridge, adjustable aerator, without pop-up waste.



N 30 L 2

Miscelatore monocomando da incasso senza deviatore per vasca/doccia.

Built-in bath/shower single lever mixer without diverter.



N 09 L 2

Miscelatore monocomando da incasso con deviatore per vasca/doccia.

Built-in bath/shower single-lever mixer with diverter.



91 NR

Bocca incasso per miscelatore vasca-doccia con cartuccia con luce a led, cm 18.

Built-in spout for bath-shower mixer with led light cartridge, cm 18.



MINIMAL COLOR



NR 02 2

Miscelatore monocomando per vasca, esterno, con cartuccia con luce a led e doccia duplex.

Single-lever bath mixer with led light cartridge, duplex shower.



NR 05 2

Miscelatore monocomando per vasca, esterno, con cartuccia con luce a led, senza doccia.

Single-lever bath mixer with led light cartridge, without shower.



NR 08 2

Miscelatore vasca da pavimento con cartuccia con luce a led, altezza bocca cm 85, con deviatore e kit doccia.

Single-lever bath mixer floor mounting with led light cartridge, spout height cm 85, with diverter and shower kit.



NR 07 2

Miscelatore monocomando bordo vasca con con cartuccia con luce a led, deviatore a molla, bocca minimale e doccetta minimale in ottone cromato.

Single lever deck bath/shower mixer with led light cartridge, spring diverter, with minimal spout and minimal chrome plated brass hand shower.



MINIMAL COLOR



NR 75 2

Miscelatore monocomando con cartuccia con luce a led, base tonda e doccetta monogetto con luce led.

Single lever mixer with led light cartridge, round base and led light one jet handshower.

Miscelatore monocomando laterale per lavello, alto, con bocca girevole a molla in acciaio inox elettrolucidata, flessibile in acciaio inox ricoperto in pvc metallizzato e doccetta monogetto.

Materiale: miscelatore in ottone cromato, doccetta in ottone cromato.

Interasse miscelatore: cm 20.

Single-lever mixer for sink, with side lever, high movable spring spout in stainless steel electro polished with shower.

Material: mixer in c.p. brass, spout in stainless steel with stainless steel flexible covered with silver colour pvc, hand shower in c.p. brass.

Mixer interaxis: cm 20.



NR 77 2

Miscelatore monocomando con cartuccia con luce a led, base tonda e doccetta monogetto con luce led.

Single lever mixer with led light cartridge, round base and led light one jet handshower.

Miscelatore monocomando laterale per lavello alto, con bocca girevole a molla in acciaio inox elettrolucidata, flessibile e doccetta monogetto.

Materiale: miscelatore in ottone cromato, molla in acciaio inox, flessibile in acciaio inox ricoperto in pvc metallizzato argento, doccetta in ottone cromato.

Altezza massima inclusa: molla cm 75.

Interasse miscelatore/doccetta: regolabile da cm 20 a cm 30 (regolazione sull'asta).

Single-lever mixer for sink, with side lever, high movable spring spout in stainless steel electro polished with hand shower.

Material: mixer in c.p. brass, spring spout in stainless steel with stainless steel flexible covered with silver colour pvc, hand shower in c.p. brass.

Maximum height of the mixer, spring included: cm 75.

Interaxis mixer/shower: from cm 20 to cm 30 (adjustable on the rod).







MINIMAL THERMO

La linea termostatica Minimal completa e definisce la sinergia tra elementi che hanno la stessa valenza progettuale e quindi intercambiabilità estetica ma presentano funzionamenti differenti per soddisfare ogni esigenza di utilizzo.

La serie termostatica attribuisce quindi quel valore aggiunto al miscelatore, dotandolo anche della funzione di esatta selezione della temperatura.

The thermostatic line Minimal complete and defines the synergy between elements that have the same design value and therefore interchangeable aesthetics but have different capabilities to meet any design and usage need.

The thermostatic series then gives to the mixer an added value, also equipping it with the function of exact temperature selection.

MINIMAL THERMO



CARATTERISTICHE TECNICHE:

La serie è dotata di cartuccia termostatica prodotta da S.T.S.R. - Studio Tecnico Sviluppo e Ricerche - www.stsr.it.

Finiture disponibili : cromo, bianco opaco, nero opaco.

TECHNICAL CHARACTERISTICS:

The series is equipped with thermostatic cartridge produced by S.T.S.R. - Research Development Technical Office - www.stsr.it.

Available finishes: chrome, matt white, matt black.



NT 31

Miscelatore esterno doccia termostatico con attacco inferiore da 1/2".
Thermostatic shower mixer, with lower 1/2" connection.



NT 35

Miscelatore esterno doccia termostatico con attacco alto da 3/4".
Thermostatic shower mixer with upper 3/4" connection.



NT 35 V

Miscelatore esterno doccia termostatico verticale, con attacco alto da 3/4".
Vertical thermostatic shower mixer, with upper 3/4" connection.



NT 39

Miscelatore monocomando termostatico esterno per doccia, con doccia duplex in ottone cromato.
Thermostatic wall mounted single-lever shower mixer, with duplex shower in C.p. brass.



Caratteristiche Tecniche serie Minimal Thermo

- Rotazione della manopola: 330° angolari
- Blocco di sicurezza: 38°C
- Campo di lavoro: da 5°C a 80°C
- Differenziale termico consigliato 50°C
- Campo di pressione in rete: da 1 a 10 bar (consigliato da 1 a 5 bar dinamici)
- Sistema di sicurezza con blocco dell'erogazione in caso di mancanza di una delle due acque
- Alta erogazione (circa 30 litri) in uscita libera

Technical data Minimal Thermo Serie

- Handle rotation: 330° angular
- Safety lock: 38°C
- Working field: from 5°C to 80°C
- Suggested thermic differential between cold and hot water: 50°C
- Pressure field: from 1 to 10 bar (suggested from 1 to 5 bar dynamic)
- Safety system with the outlet lock in case there is one water lock
- High flow rate (about 30 liters) in free outlet

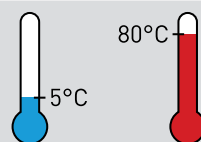
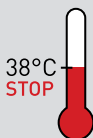

NT 37

Set doccia composto da: Miscelatore termostatico esterno doccia **NT 35** con colonna doccia deluxe con saliscendi e deviatore, doccetta anticalcare in ottone cromato **317MM** e soffione in abs cromato e anticalcare **359 MM 20**. Flessibile in ottone cromato incluso.

Shower set composed by: External thermostatic shower single lever mixer **NT 35** with deluxe shower column with sliding central and diverter, including anti-limestone handshower in c.p. brass **317MM** and showerhead in c.p. abs **359 MM 20** with silicone jets, anti-limestone. Shower flexible in c.p. brass included.



NT 37 XL

Set doccia composto da: Miscelatore termostatico esterno doccia **NT 35** con colonna doccia deluxe con saliscendi e deviatore, doccetta anticalcare in ottone cromato **317MM** e soffione ultrapiatto in ottone cromato e anticalcare **359MM XL**. Flessibile in ottone cromato incluso.

Shower set composed by: External thermostatic shower single lever mixer **NT 35** with deluxe shower column with sliding central and diverter, including anti-limestone handshower in c.p. brass **317MM** and ultrathin showerhead in c.p. brass **359MM XL** with silicone jets, anti-limestone. Shower flexible in c.p. brass included.

MINIMAL THERMO



NT 37 B

Set doccia composto da:

Miscelatore termostatico esterno doccia **NT 35** con colonna doccia minimale con saliscendi e deviatore, doccetta anticalcare in abs cromato **317DM** e soffione in abs cromato e anticalcare **356MD 20** Ø cm 20. Flessibile in ottone cromato incluso.

Shower set composed by:

External thermostatic shower single lever mixer **NT 35** with minimal shower column with sliding central and diverter, including anti-limestone handshower in abs **317DM** and showerhead in c.p. abs **356MD 20** Ø cm 20, with silicone jets, anti-limestone. Shower flexible in c.p. brass included.



NT 37 B XL

Set doccia composto da:

Miscelatore termostatico esterno doccia **NT 35** con colonna doccia minimale con saliscendi e deviatore, doccetta anticalcare in abs cromato **317DM** e soffione in abs cromato e anticalcare **356MD 25** Ø cm 25. Flessibile in ottone cromato incluso.

Shower set composed by:

External thermostatic shower single lever mixer **NT 35** with minimal shower column with sliding central and diverter, including anti-limestone handshower in abs **317DM** and showerhead in c.p. abs **356MD 25** Ø cm 25 with silicone jets, anti-limestone. Shower flexible in c.p. brass included.

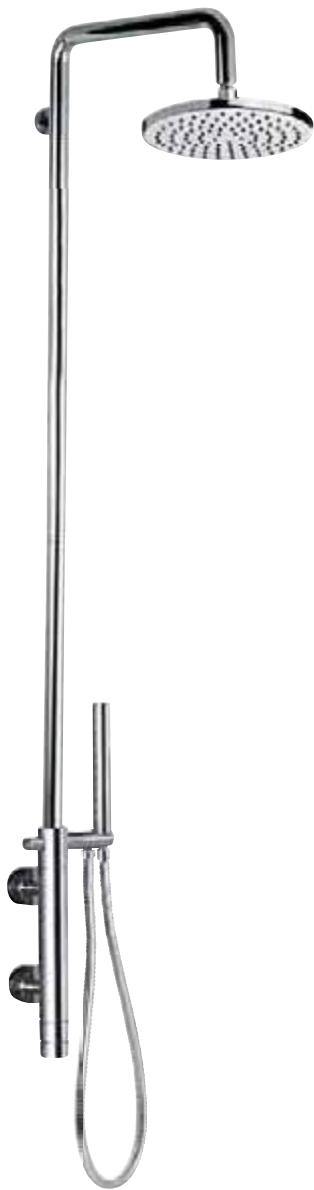

NT 36

Set doccia composto da:

Miscelatore termostatico verticale esterno doccia **NT 35 V** con colonna doccia deluxe con saliscendi e deviatore **NT 35V DEV**, doccetta anticalcare in ottone cromato **317MM** e soffione in abs cromato e anticalcare **359 MM 20**. Flessibile in ottone cromato incluso.

Shower set composed by:

External vertical thermostatic shower single lever mixer **NT 35 V** with deluxe shower column with sliding central and diverter **NT 35V DEV**, including anti-limestone handshower in c.p. brass **317MM** and showerhead in c.p. abs **359MM 20** with silicone jets, anti-limestone. Shower flexible in c.p. brass included.



NT 36 XL

Set doccia composto da:

Miscelatore termostatico verticale esterno doccia **NT 35 V** con colonna doccia deluxe con saliscendi e deviatore **NT 35V DEV**, doccetta anticalcare in ottone cromato **317MM** e soffione ultrapiatto in ottone cromato e anticalcare **359MM XL**. Flessibile in ottone cromato incluso.

Shower set composed by:

External vertical thermostatic shower single lever mixer **NT 35 V** with deluxe shower column with sliding central and ultrathin diverter **NT 35V DEV**, including anti-limestone handshower in c.p. brass **317MM** and showerhead in c.p. brass **359MM XL** with silicone jets, anti-limestone. Shower flexible in c.p. brass included.

MINIMAL THERMO



NT 36 B

Set doccia composto da:

Miscelatore termostatico esterno doccia **NT 35V** con colonna doccia minimale con saliscendi e deviatore **NT 35V DEV**, doccetta anticalcare in abs cromato **317DM** e soffione in abs cromato e anticalcare **356MD** Ø 20 cm. Flessibile in ottone cromato incluso.

Shower set composed by:

External thermostatic shower single lever mixer **NT 35V** with minimal shower column with sliding central and diverter **NT 35V DEV**, including anti-limestone handshower in abs **317DM** and showerhead in c.p. abs **356MD** Ø 20 cm, with silicone jets, anti-limestone. Shower flexible in c.p. brass included.



NT 36 B XL

Set doccia composto da:

Miscelatore termostatico esterno doccia **NT 35V** con colonna doccia minimale con saliscendi e deviatore **NT 35V DEV**, doccetta anticalcare in abs cromato **317DM** e soffione in abs cromato e anticalcare **356MD** Ø 25 cm. Flessibile in ottone cromato incluso.

Shower set composed by:

External thermostatic shower single lever mixer **NT 35V** with minimal shower column with sliding central and diverter **NT 35V DEV**, including anti-limestone handshower in abs **317DM** and showerhead in c.p. abs **356MD** Ø 25 cm with silicone jets, anti-limestone. Shower flexible in c.p. brass included.



MINIMAL THERMO



NT 30

Miscelatore termostatico da incasso per doccia, senza deviatore.

Thermostatic built-in mixer for shower, without diverter.



NT 09

Miscelatore termostatico da incasso con deviatore per vasca-doccia.

Thermostatic built-in single-lever mixer, with diverter for bath-shower.



NT 92

Miscelatore termostatico per doccia, con deviatore a due posizioni (due uscite ed una entrata) su piastra unica.

Thermostatic shower mixer with 2 positions diverter (2 outlets and 1 inlet) on single flange.



NT 93

Miscelatore termostatico per doccia con deviatore a tre vie (una entrata e tre uscite) su unica piastra.

Thermostatic built-in shower mixer with three ways diverter (1 inlet and 3 outlets) on single flange.

NT 93 7

Miscelatore termostatico per doccia con deviatore a tre vie e sette posizioni (una entrata, tre uscite e sette posizioni con cui selezionare uscite singole o miscelate tra loro) su unica piastra.

Scatti della maniglia-deviatore:

- lo scatto 1 aziona l'acqua dell'uscita 1
- lo scatto 2 aziona l'acqua dell'uscita 2
- lo scatto 3 aziona l'acqua dell'uscita 3
- lo scatto 4 aziona l'acqua dell'uscita 1
- lo scatto 5 aziona l'acqua delle uscite 1 + 2
- lo scatto 6 aziona l'acqua delle uscite 1 + 2 + 3
- lo scatto 7 aziona l'acqua delle uscite 2 + 3

Thermostatic built-in shower mixer with three ways diverter with seven positions (1 inlet and 3 outlets and seven positions to select single or mixed outlets) on single flange.

Handle steps of the diverter :

- 1st step to run water from outlet 1
- 2nd step to run water from outlet 2
- 3rd step to run water from outlet 3
- 4th step to run water from outlet 1
- 5th step to run water from outlets 1 + 2
- 6th step to run water from outlets 1 + 2 + 3
- 7th step to run water from outlets 2 + 3



NT 94

Miscelatore termostatico per doccia, con deviatore a 4 posizioni (4 uscite ed 1 entrata) su piastra unica.

Thermostatic shower mixer with 4 positions diverter (4 outlets and 1 inlet) on single flange.

NT 95

Miscelatore termostatico per doccia, con deviatore a 5 posizioni (5 uscite ed una entrata) su piastra unica.

Thermostatic shower mixer with 5 positions diverter (5 outlets and 1 inlet) on single flange.



NT 94 C

Miscelatore termostatico per doccia, con deviatore a 4 posizioni (4 uscite ed 1 entrata) su doppia piastra, con possibilità di chiusura del flusso dal deviatore durante il cambio di posizione (col vantaggio di non azionare posizioni non desiderate e non dover toccare la maniglia che seleziona anche la temperatura).

Thermostatic shower mixer with 4 positions diverter (4 outlets and 1 inlet) on double flange, with the possibility of closing the flow from the diverter during the position change (with the advantage of not starting the undesired positions and also not having touch the handle that also selects the temperature).

NT 95 C

Miscelatore termostatico per doccia, con deviatore a 5 posizioni (5 uscite ed una entrata) su doppia piastra, con possibilità di chiusura del flusso dal deviatore durante il cambio di posizione (col vantaggio di non azionare posizioni non desiderate e non dover toccare la maniglia che seleziona anche la temperatura).

Thermostatic shower mixer with 5 positions diverter (5 outlets and 1 inlet) on double flange, with the possibility of closing the flow from the diverter during the position change (with the advantage of not starting the undesired positions and also not having touch the handle that also selects the temperature).

La cartuccia termostatica usata all'interno dei nostri articoli NT93 e NT93 7 è completamente intercambiabile con la nostra cartuccia standard da 40mm art. S52. Questo consente a distanza di tempo e per qualsiasi Vostra necessità di variare l'impianto da termostatico in tradizionale o viceversa, rendendo un ottimo servizio in termini di sicurezza sulla funzionalità.

The thermostatic cartridge used in our articles NT93 and NT 93 7 is completely interchangeable with our standard Ø 40mm cartridge art. S52. This system allows in time and for any of Your needs to change the installation from thermostatic to traditional or the contrary, giving the best service in terms of safety on functionality.

MINIMAL THERMO WELLNESS



NT 09 S01

Set doccia composto da:

Art. 356LU 348N 30: Soffione minimale anticalcare con braccio in ottone cm 30.

Art. 317M 317DM con 333CN 150: Saliscendi minimale con doccetta anticalcare e flessibile conico in ottone cromato.

Art. 309 L: presa acqua tipo rotondo pesante.

Art. NT 09 L: Miscelatore incasso con deviatore e piastra lusso.

Shower set composed by:

Art. 356LU 348N 30: Minimal anti-limestone showerhead with arm in brass cm 30.

Art. 317M 317DM with 333CN 150: Minimal sliding bar with anti-limestone handshower and with shower flexible hose in brass cm 150.

Art. 309 L: C.p. brass wall connector, round heavy type

Art. NT 09 L: Built-in mixer with diverter and deluxe flange.



NT 09 S02

Set doccia composto da:

Art. 356LU 348N 30: Soffione minimale anticalcare con braccio in ottone cm 30.

Art. 337M 317DM con 333CN 150: Doccia duplex minimale anticalcare con supporto presa acqua e flessibile conico in ottone cromato cm 150.

Art. NT 09 L: Miscelatore incasso con deviatore e piastra lusso.

Shower set composed by:

Art. 356LU 348N 30: Minimal anti-limestone showerhead with arm in brass cm 30.

Art. 337M 317DM with 333CN 150: Duplex water punch with anti-limestone handshower with shower flexible hose in brass cm 150.

Art. NT 09 L: Built-in mixer with diverter and deluxe flange.



NT 09 S03

Set doccia composto da:

Art. 356LU 348N 30: Soffione minimale anticalcare con braccio in ottone cm 30.

Art. 339N 317DM con 333CN 150: Doccia duplex minimale anticalcare con supporto duplex e flessibile conico in ottone cromato cm 150.

Art. 91 MD: Bocca incasso Minimal con deviatore integrato.

Art. NT 09 L: Miscelatore incasso con deviatore e piastra lusso

Shower set composed by:

Art. 356LU 348N 30: Minimal anti-limestone showerhead with arm in brass cm 30

Art. 339N 317DM with 333CN 150: Minimal anti-limestone handshower with shower flexible hose in brass cm 150 and duplex shower holder

Art. 91 MD: Minimal built-in spout with diverter.

Art. NT 09 L: Built-in mixer with diverter with deluxe flange.



NT 09 S11

Set doccia composto da:

Art. 330U 356LU 317DM 330RA con 333CN 150: Colonna doccia deluxe girevole con deviatore e saliscendi, completa di soffione doccia cromato anticalcare, doccetta minimale, flessibile doccia e supporto presa acqua per colonna.

Art. NT 09 L: Miscelatore monocomando incasso con deviatore e piastra lusso .

Art. 91M: Bocca incasso Minimale.

Shower set composed by:

Art. 330U 356LU 317DM 330RA with 333CN 150: Swivable deluxe shower column with diverter and sliding rail, with anti-limestone showerhead and handshower, flexible in c.p. brass cm 150 and water punch-support for columns.

Art. NT 09 L: Single-lever built-in shower mixer with diverter and deluxe flange

Art. 91M: Minimal built-in spout.



NT 93 7 S01

Set doccia composto da:

Art. 359MM30 348N 30: soffione minimale anticalcare in ottone Ø 30, con braccio in ottone cm 30.

Art. 337M 321HG con 333CN 150: Doccia minimale a 2 funzioni, con getti in silicone, supporto doccia duplex in ottone cromato con presa acqua e flessibile conico in ottone cromato cm 150.

Art. N 34 JET: 6 getti minimali anticalcare in ottone cromato.

Art. NT 93 7: miscelatore monocomando per doccia con deviatore a tre vie e sette posizioni su unica piastra.

Shower set composed by:

Art. 359MM30 348N 30: Minimal anti-limestone shower head in c.p. brass Ø 30 cm with arm in brass cm 30.

Art. 337M 321HG with 333CN 150: water-punch in c.p. brass with duplex holder, minimal handshower, 2 functions, with silicon jets, with shower flexible hose in brass cm 150.

Art. N 34 JET: 6 Minimal jets anti-limestone in c.p. brass.

Art. NT 93 7: single lever built-in shower mixer with three ways diverter with seven position on single flange.



NT 93 7 S02

Set doccia composto da:

Art. 359MM30 348N 30: soffione minimale anticalcare in ottone Ø 30, con braccio in ottone cm 30.

Art. 317G 321HG con 333CN 150: Saliscendi in ottone cromato e doccetta minimale a 2 funzioni con getti in silicone e flessibile conico in ottone cromato cm 150.

Art. N 34 JET: 6 getti minimali anticalcare.

Art. NT 93 7: miscelatore monocomando per doccia con deviatore a tre vie e sette posizioni su unica piastra.

Shower set composed by:

Art. 359MM30 348N 30: Minimal anti-limestone shower head in c.p. brass Ø 30 cm with arm in brass cm 30.

Art. 317G 321HG with 333CN 150: Minimal c.p. brass sliding bar with handshower 2 functions with silicon jets and and with flexible hose in brass cm 150.

Art. N 34 JET: 6 Minimal jets anti-limestone in c.p. brass

Art. NT 93 7: single lever built-in shower mixer with three ways diverter with seven position on single flange.



NT 93 7 S03

Set doccia composto da:

Art. 359MM30 348N 30: soffione minimale anticalcare in ottone Ø 30, con braccio in ottone cm 30.

Art. 337M 321HG con 333CN 150: Doccia minimale a 2 funzioni, con getti in silicone, supporto doccia duplex in ottone cromato con presa acqua e flessibile conico in ottone cromato cm 150.

Art. 91 M: bocca incasso minimale.

Art. NT 93 7: miscelatore monocomando per doccia con deviatore a tre vie e sette posizioni su unica piastra.

Shower set composed by:

Art. 359MM30 348N 30: Minimal anti-limestone shower head in c.p. brass Ø 30 cm with arm in brass cm 30.

Art. 337M 321HG with 333CN 150: water-punch in c.p. brass with duplex holder, minimal handshower, 2 functions, with silicon jets, with shower flexible hose in brass cm 150.

Art. 91 M: built-in minimal spout .

Art. NT 93 7: single lever built-in shower mixer with three ways diverter with seven position on single flange.



NT 30 S12

Sistema doccia completo deluxe composto da:

Art. NT 30 L: miscelatore incasso doccia con piastra deluxe

Art. 330U 359MM30 321HG 330RA con 333CN 150: Colonna doccia deluxe girevole con deviatore e saliscendi, completa di soffione doccia cromato anticalcare e doccetta minimale a 2 funzioni con getti in silicone e supporto presa acqua per colonna.

Complete deluxe shower system composed by:

Art. NT 30 L: built-in shower mixer with deluxe flange

Art. 330U 359MM30 321HG 330RA con 333CN 150: Adjustable Deluxe shower column with diverter and sliding rail, with c.p. anti-limestone showerhead and minimal handshower, 2 functions, with silicon jets and water punch-support for columns.



JAZZ

Linea elegante e raffinata, giocata su elementi circolari e linee minimali tonde, ha come elemento distintivo l'uso della cartuccia a Joystick che favorisce un funzionamento di tipo intuitivo a rotazione, differentemente dalla classica cartuccia a leva.

La particolarità del funzionamento Joystick porta la leva a slanciarsi verso l'alto ed elevare ulteriormente il valore estetico del miscelatore.

Elegant and refined series, played on circular elements and minimal round lines, it has the distinction of the joystick cartridge that facilitates an intuitive rotation operation, differently from the classical lever cartridge. The peculiarity of the joystick operation push the lever upward thus further increasing the aesthetic value of the mixer.



CARATTERISTICHE TECNICHE:

La serie è dotata di cartuccia a dischi ceramici joystick Ø 35 mm, prodotta da S.T.S.R. - Studio Tecnico Sviluppo e Ricerche - www.stsr.it

Finiture disponibili: cromo, bianco opaco, nero opaco.

TECHNICAL CHARACTERISTICS:

The series is equipped with joystick ceramic cartridge, Ø 35 mm, produced by S.T.S.R. - Research Development Technical Office - www.stsr.it

Available finishes: chrome, matt white, matt black.



J 10

Miscelatore monocomando per lavabo, con scarico.

Single-lever basin mixer with pop-up waste.

J 11

Miscelatore monocomando per lavabo, senza scarico.

Single-lever basin mixer without pop-up waste.



J 10 L

Miscelatore monocomando per lavabo, su colonna, con scarico.

Single-lever basin mixer, high neck, with pop-up waste.

J 10 L B

Come J 10 L, con scarico click-clack senza troppo pieno.

As J 10 L, with click-clack waste without overflow.

J 11 L

Come J 10 L, senza scarico.

As J 10 L, without click-clack waste.



J 15

Miscelatore monocomando a incasso per lavabo serie Jazz, con piastra rettangolare in ottone cromato e bocca minimal cm 18.

Single lever built-in basin mixer serie Jazz, with rectangular wall flange in chrome plated brass and minimal spout length cm 18.



J 10 LXL

Miscelatore monocomando per lavabo, su colonna, altezza bocca cm 25, lunghezza bocca cm 18, con scarico.

Single-lever basin mixer, high neck, height of spout cm 25, length of spout cm 18, with pop-up waste.

J 10 LXL B

Come J 10 LXL, con scarico click-clack senza troppo pieno.

As J 10 LXL, with click-clack waste without overflow.

J 11 LXL

Come J 10 LXL, senza scarico.

As J 10 LXL, without click-clack waste.



J 20

Miscelatore monocomando per bidet, con aeratore direzionabile e con scarico.

Single-lever bidet mixer with adjustable aerator and pop-up waste.

J 21

Miscelatore monocomando per bidet, senza scarico.

Single-lever bidet mixer without pop-up waste.



J 23

Miscelatore monocomando per bidet con doccetta.

Single-lever bidet mixer with spray.



J 02

Miscelatore monocomando per vasca, esterno, con doccia duplex.

Single-lever bath mixer with duplex shower.

J 05

Miscelatore monocomando per vasca, esterno, senza doccia.

Single-lever bath mixer without shower.



J 07

Miscelatore monocomando bordo vasca serie Jazz con deviatore, bocca minimale e doccetta minimale in ottone cromato.

Single lever deck bath/shower mixer serie Jazz with diverter, with minimal spout and minimal chrome plated brass hand shower.



J 06

Miscelatore monocomando bordo vasca con deviatore, bocca con effetto multigetto e doccetta in ottone cromato.

Single lever deck bath/shower mixer with diverter, spout with multijets effect and c.p. brass hand shower.







J 09

Miscelatore monocomando da incasso per doccia.
Built-in shower single lever mixer.



J 30

Miscelatore monocomando da incasso con deviatore per vasca/doccia.
Built-in bath/shower single-lever mixer with diverter.



J 09 L

Miscelatore monocomando da incasso per doccia, con piastra lusso.
Built-in shower single lever mixer, with deluxe flange.



J 30 L

Miscelatore monocomando da incasso con deviatore per vasca/doccia, con piastra lusso.
Built-in bath/shower single-lever mixer with diverter, with deluxe flange.



91 M

Bocca incasso per miscelatore vasca-doccia, 18 cm.
Built-in spout for bath-shower mixer 18 cm.



91 MD

Bocca incasso per miscelatore vasca-doccia, con deviatore integrato, cm 18.
Built-in spout for bath-shower mixer, with diverter, cm 18.



317M 317DM

Saliscendi minimale con doccetta anticalcare.
Minimal sliding rail set with anti-limestone handshower.



J 35

Gruppo doccia a muro.
Wall mounted shower mixer.



J 31

Miscelatore monocomando esterno per doccia.
Wall mounted single-lever shower mixer.



J 39

Miscelatore monocomando esterno per doccia, con doccia duplex.
Wall mounted single-lever shower mixer, with duplex shower.







J 37

Miscelatore esterno doccia con deviatore integrato, con colonna saliscendi girevole, completo di doccetta anticalcare con flessibile e soffione, il tutto in ottone cromato.

External shower single lever mixer with diverter, with swivable sliding column, anti-limestone handshower with flexible hose and shower head, all in c.p. brass.



J 37 B

Miscelatore esterno doccia con deviatore integrato, con colonna saliscendi girevole, completo di doccetta anticalcare con flessibile e soffione, in abs cromato, cm 20.

External shower single lever mixer with diverter, with swivable sliding column, anti-limestone handshower with flexible hose and shower head, in c.p. abs, cm 20.



J 40

Miscelatore monocomando per lavello, con bocca girevole.
Single-lever one-hole sink mixer, with movable spout.



J 40 L

Come J 40 con altezza bocca mm 280
Means above J 40, with height of spout mm 280.



J 47

Miscelatore monocomando per lavello, con doccia estraibile in ottone cromato.
Single-lever one-hole sink mixer, with pull-out spray jet shower in c.p. brass.



J 41

Miscelatore monocomando per lavello a muro, con bocca girevole.
Single-lever wall mounted sink mixer, with movable spout.



J 48 319 MO

Miscelatore monocomando bordo lavello serie Jazz con deviatore, bocca minimale e doccetta cromata minimale a 2 funzioni con getti in silicone, idromassaggio ed anticalcare.

Single lever deck sink mixer serie Jazz with diverter, with C.p. minimal handshower 2 functions hydromassage, anti-limestone with silicone jets.



J 48 332 EU

Miscelatore monocomando bordo lavello serie Jazz con deviatore, bocca minimale e doccetta a pulsante minimale in Abs cromata con impugnatura liscia 1/2".

Single lever deck sink mixer serie Jazz with diverter, with C.p. Abs minimal shut-off, with plain handgrip 1/2".





E A G L E

La serie di miscelatori termostatici Eagle si caratterizza da un design moderno e ma anche molto morbido. Lo studio delle forme arrotondate e dolci si ripresenta in ogni elemento della serie, donando un ambito di grande resa estetica.

Eagle è una serie di miscelatori termostatici prestigiosa e adatta ad ogni ambiente bagno nel quale si voglia creare un senso di raffinata solidità e morbida eleganza.

Eagle thermostatic mixers are characterised by a modern design where the line is always very smooth. The study of rounded shapes and soft is present in every element of the line

giving an environment of great aesthetic impact.

Eagle is a prestigious line of thermostatic mixers suitable for every bathroom in which the idea is to create a feeling of refined solidity and smooth elegance.



Caratteristiche Tecniche:

- Rotazione della manopola: 330° angolari
- Blocco di sicurezza: 38°C
- Campo di lavoro: da 5°C a 80°C
- Differenziale termico consigliato 50°C
- Campo di pressione in rete: da 1 a 10 bar (consigliato da 1 a 5 bar dinamici)
- Sistema di sicurezza con blocco dell'erogazione in caso di mancanza di una delle due acque
- Alta erogazione (circa 30 litri) in uscita libera
- Filtri in acciaio inox per il trattamento delle impurità

I termostatici serie Eagle si caratterizzano inoltre per la loro migliore funzionalità; difatti, al contrario della maggior parte della rubinetteria termostatica in commercio, l'apertura dell'acqua (funzione usata quotidianamente) avviene tramite la maniglia destra mentre il settaggio della temperatura (funzione usata più sporadicamente) avviene tramite la manopola sinistra. Nonostante la produzione della serie Eagle sia tecnicamente più difficile, siamo sicuri di dare ai nostri clienti un prodotto ancor più valido.

Technical data:

- Handle rotation: 330° angular
- Safety lock: 38°C
- Working field: from 5°C to 80°C
- Suggested thermic differential between cold and hot water: 50°C
- Pressure field: from 1 to 10 bar (suggested from 1 to 5 bar dynamic)
- Safety system with the outlet lock in case there is one water lock
- High flow rate (about 30 liters) in free outlet
- Stainless steel filters to keep the impurity

Thermostatic mixers serie Eagle features are further characterised by the best functionality. In fact, contrary to the main part of other producers thermostatics, in Eagle line the opening of the water flow (function used daily) has been studied to be positioned on the right lever while the temperature setting (function used more rarely) is positioned on the left lever. Even if Serie Eagle's production becomes for this reason technically more difficult, we are sure to give to our customers a product even more valuable.

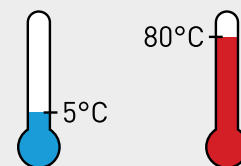
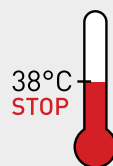
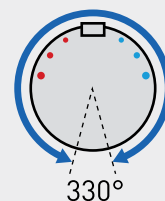

La serie è dotata di cartuccia termostatica prodotta da S.T.S.R. - Studio Tecnico Sviluppo e Ricerche - www.stsr.it

The series is equipped with thermostatic cartridge produced by S.T.S.R. - Research Development Technical Office - www.stsr.it



E 10

Miscelatore termostatico per lavabo con pulsante di sicurezza a 38°, completo di scarico.

Thermostatic basin mixer with 38° safety push button, complete with pop-up waste.

E 11

Miscelatore termostatico per lavabo con pulsante di sicurezza a 38°, senza scarico.

Thermostatic basin mixer with 38° safety push button, without pop-up waste.



E 20

Miscelatore termostatico per bidet, con pulsante di sicurezza a 38°, con aeratore direzionabile e completo di scarico.

Thermostatic bidet mixer with 38° safety push button and adjustable aerator, complete with pop-up waste.

E 21

Miscelatore termostatico per bidet, con pulsante di sicurezza a 38°, con aeratore direzionabile, senza scarico.

Thermostatic bidet mixer with 38° safety push button and adjustable aerator, without pop-up waste.



E 02

Miscelatore termostatico esterno vasca con pulsante di sicurezza 38° e completo di kit duplex.

Thermostatic bath mixer with 38° safety push button and duplex shower kit.

E 05

Miscelatore termostatico esterno vasca con pulsante di sicurezza 38°, senza kit doccia.

Thermostatic bath mixer with 38° safety push button, without shower set.



E 30

Miscelatore termostatico incasso vasca/doccia con pulsante di sicurezza a 38°.

Built-in thermostatic bath/shower mixer with 38° safety push button.



E 39

Miscelatore termostatico esterno doccia con pulsante di sicurezza 38° e completo di kit saliscendi.

Thermostatic shower mixer with 38° safety push button and sliding rail shower kit.

E 31

Miscelatore termostatico esterno doccia con pulsante di sicurezza 38°, senza kit doccia.

Thermostatic shower mixer with 38° safety push button, without shower set.



E 30 S 11

Sistema doccia completo deluxe composto da miscelatore termostatico incasso doccia art E30 e colonna saliscendi lusso girevole art 330R con deviatore, doccetta anticalcare, soffione anticalcare in ottone cromato, flessibile doccia in ottone, il tutto collegato tramite supporto colonna - presa acqua lusso art. 330RA.

Complete deluxe shower system composed by built-in thermostatic shower mixer art E30, swivable deluxe sliding shower column art 330R with diverter, anti-limestone handshower, anti-limestone showerhead in brass, flexible hose in brass, all connected through the punch for water and wall bearing deluxe art.330RA.



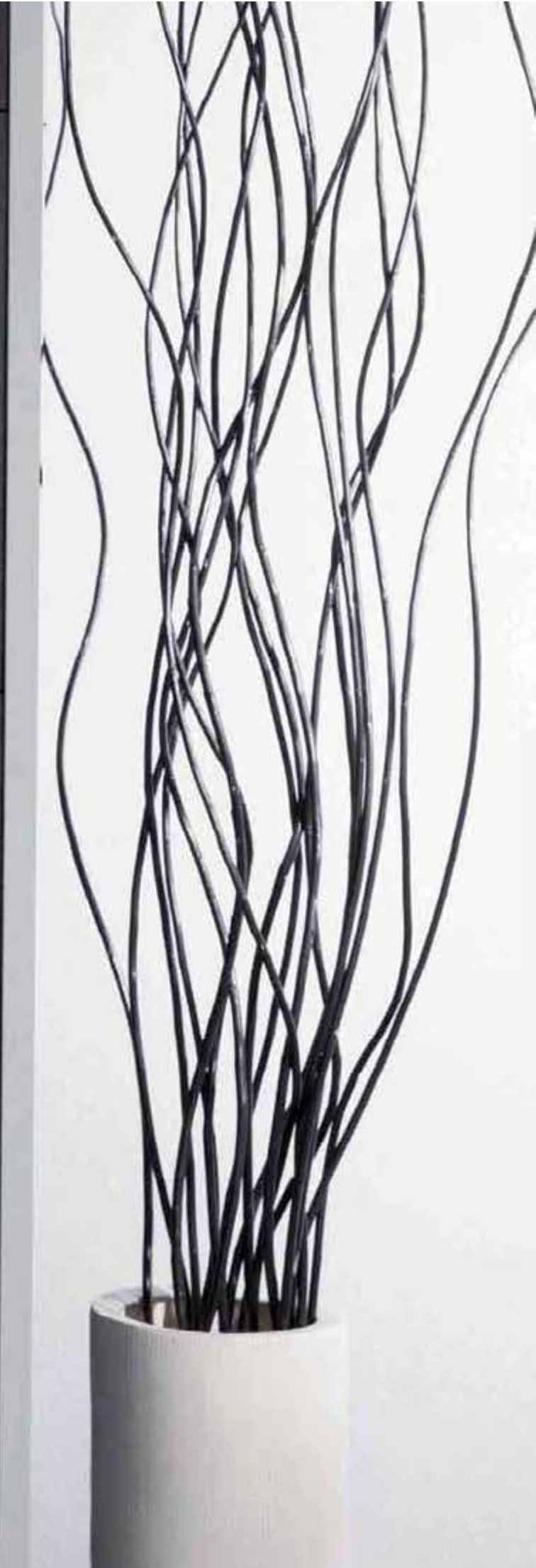





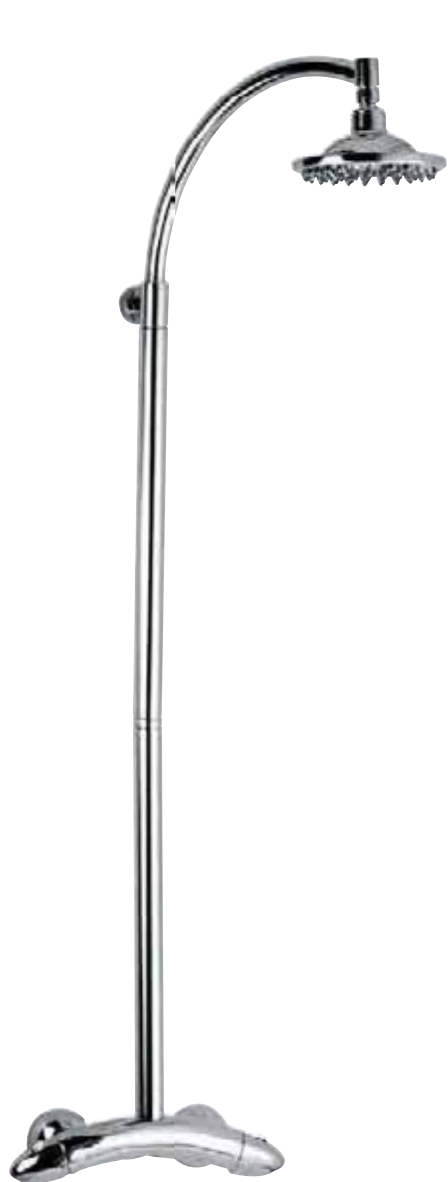

E 36

Miscelatore termostatico esterno doccia con pulsante di sicurezza a 38°, su colonna girevole e soffione anticalcare, il tutto in ottone cromato.

Thermostatic shower mixer with 38° safety push button, with swivelling column and anti-limestone shower head, all in c.p. brass.



E 37

Miscelatore termostatico esterno doccia con pulsante di sicurezza a 38°, con colonna saliscendi girevole e deviatore, completa di doccetta anticalcare con flessibile e soffione anticalcare in ottone cromato.

Thermostatic shower mixer with 38° safety push button, with swivelling sliding column with diverter, anti-limestone handshower with flexible hose and c.p. brass anti-limestone shower head.



E 35

Miscelatore termostatico esterno doccia con pulsante di sicurezza 38°.

Thermostatic shower mixer with 38° safety push button.



E 49

Miscelatore lavabo/vasca con canna fusa lunga 30 cm e deviatore con kit doccia.

Wall basin/bath single lever mixer with 30 cm long casted spout with diverter and duplex shower.



E 46

Miscelatore lavabo/vasca con canna fusa lunga 30 cm e deviatore senza kit doccia.

Wall basin/bath single lever mixer with 30 cm long casted spout with diverter without duplex shower.



E 40

Miscelatore termostatico per lavello con pulsante di sicurezza a 38° e bocca alta girevole fusa tipo lusso.

Thermostatic sink mixer with 38° safety push button and high movable casted spout, luxury type.



E 41

Miscelatore termostatico per lavello a muro con pulsante di sicurezza a 38° e bocca girevole.

Thermostatic wall mounted sink mixer with 38° safety push button and movable spout.



E 42

Miscelatore termostatico per lavello a muro con pulsante di sicurezza a 38° e bocca alta girevole.

Thermostatic wall mounted sink mixer with 38° safety push button and high movable spout.



THERMO

La serie di miscelatori termostatici Thermo è stata progettata con un design deciso ma basato su linee essenziali. Le caratteristiche tecniche e qualitative sono comunque pari alle serie termostatiche più alte di gamma rendendo la serie Thermo una buona scelta per chi desidera un miscelatore termostatico di qualità ma su una fascia di mercato più competitiva.

Thermo thermostatic mixers line has been created with a firm design but based on essential lines. The technical and qualitative features are indeed even to the other higher ranges thermostatic mixers making the Thermo line a good choice for who wishes to have a quality thermostatic mixers but on a more competitive market segment.



CARATTERISTICHE TECNICHE:

La serie è dotata di cartuccia termostatica prodotta da S.T.S.R. - Studio Tecnico Sviluppo e Ricerche - www.stsr.it

TECHNICAL CHARACTERISTICS:

The series is equipped with thermostatic cartridge produced by S.T.S.R. - Research Development Technical Office - www.stsr.it



H 10

Miscelatore termostatico lavabo con scarico.
Thermostatic basin mixer with pop-up waste.

H 11

Miscelatore termostatico lavabo senza scarico.
Thermostatic basin mixer without pop-up waste.



H 20

Miscelatore termostatico bidet con aeratore direzionabile e con scarico.
Thermostatic bidet mixer with adjustable aerator and pop-up waste.

H 21

Miscelatore termostatico bidet con aeratore direzionabile e senza scarico.
Thermostatic bidet mixer with adjustable aerator, without pop-up waste.

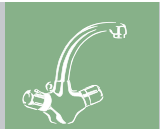

H 02
Miscelatore termostatico monoblocco vasca doccia con set doccia.
Thermostatic monobloc bath mixer with shower set.



H 39 D
Miscelatore termostatico doccia esterno con set doccia.
Thermostatic shower mixer with shower set.

H 05
Miscelatore termostatico monoblocco vasca doccia senza set doccia.
Thermostatic monobloc bath mixer without shower set.

H 31
Miscelatore termostatico doccia esterno senza set doccia.
Thermostatic shower mixer without shower set.



H 39
Miscelatore termostatico doccia esterno con saliscendi.
Thermostatic shower mixer with sliding bar.



H 40
Miscelatore termostatico per lavello con bocca alta girevole.
Thermostatic sink with high swivelling spout.





FUTURA

Una serie di miscelatori monocomando caratterizzata da linee sinuose, eleganti e morbide che ben si adattano ad ambienti sia classici che moderni caratterizzandoli con un design armonico e particolare.

La serie Futura si compone di diversi elementi ognuno caratterizzato al meglio della particolarità della serie stessa in un gioco di volumi linee e rotondità.

A series of single-lever mixers characterized by sinuous, elegant and soft lines which are well suited to both classic and modern environment characterizing them with a particular and harmonious design.

The Futura series consists of several elements, each one characterized at best of the particular in a game of volumes, lines and curves.



CARATTERISTICHE TECNICHE:

La serie è dotata di cartuccia a dischi ceramici Ø 35 mm, prodotta da S.T.S.R. - Studio Tecnico Sviluppo e Ricerche - www.stsr.it

Finiture disponibili: cromo, cromo oro.

TECHNICAL CHARACTERISTICS:

The series is equipped with ceramic cartridge, Ø 35 mm, produced by S.T.S.R. - Research Development Technical Office - www.stsr.it

Available finishes: chrome, chrome gold.



U 10

Miscelatore monocomando per lavabo, con scarico.
Single-lever basin mixer with pop-up waste.

U 11

Miscelatore monocomando per lavabo, senza scarico.
Single-lever basin mixer without pop-up waste.



U 20

Miscelatore monocomando per bidet, con aeratore direzionabile e con scarico.
Single-lever bidet mixer with adjustable aerator and pop-up waste.

Single-lever bidet mixer with adjustable aerator and pop-up waste.

U 21

Miscelatore monocomando per bidet, con aeratore direzionabile e senza scarico.
Single-lever bidet mixer with adjustable aerator, without pop-up waste.

Single-lever bidet mixer with adjustable aerator, without pop-up waste.



U 02

Miscelatore monocomando per vasca, esterno, con doccia duplex.
Single-lever bath mixer with duplex shower.

U 05

Miscelatore monocomando per vasca, esterno, senza doccia.
Single-lever bath mixer without shower.



U 07

Miscelatore monocomando bordo vasca serie Futura, con bocca pesante fusa con deviatore e doccetta Futura in ottone cromato.
Single lever deck bath/shower mixer serie Futura with heavy casted spout with diverter and Futura handshower in cp brass.

Single lever deck bath/shower mixer serie Futura with heavy casted spout with diverter and Futura handshower in cp brass.



U 09
Miscelatore monocomando da incasso per doccia.
Built-in shower single-lever mixer.



U 30
Miscelatore monocomando da incasso con deviatore per vasca/doccia.
Built-in bath/shower single-lever mixer with diverter.



U 39
Miscelatore monocomando esterno per doccia, con kit doccia.
Wall mounted single-lever shower mixer, with shower kit.



U 31
Miscelatore monocomando esterno per doccia.
Wall mounted single-lever shower mixer.



U 41
Miscelatore monocomando per lavello a muro, con bocca girevole.
Single-lever wall mounted sink mixer, movable spout.



U 40
Miscelatore monocomando per lavello, con bocca girevole.
Single-lever one-hole sink mixer, movable spout.



U 42 2
Monocomando lavello con bocca alta girevole.
Single lever kitchen mixer with high movable spout.



U 47 2
Monocomando lavello con bocca alta girevole e doccetta estraibile.
Single lever kitchen mixer with high movable spout, with pull out spray.



BLUE

Per impreziosire e combinare ambienti in cui il colore è il tema predominante, Blue si veste per voi con la molteplice scelta cromatica dei particolari quali maniglia, pomolo vasca, impugnatura doccia, pomolo saltarello.

Allo stesso modo, per creare un'atmosfera vintage, la maniglia dedicata Vintage della serie Blue, con inserto in ceramica bianca, saprà trasferire l'emozione desiderata.

To embellish and combine the bathrooms ambients in which colour is the predominant theme, Blue dresses for you with the multiple colour choice of details like handle, bathtub knob, handshower grip, pop-up knob... In the same way, to create some Vintage effect, the dedicated Vintage of Blue line, with white ceramic insert, will be able to transfer you the desired emotion.



BLUE



B 10 BL
Blu
Blue



B 10 RO
Rosso
Red



B 10 GI
Giallo
Yellow



B 10 VE
Verde
Green



B 10 CR
Cromo
Chrome



B 10 CD
Oro
Gold



B 10 CS
Satinato
Satin



B 10 VN
Vintage
Vintage

CARATTERISTICHE TECNICHE:

La serie è dotata di dischi ceramici Ø 35 mm, prodotti da S.T.S.R. - Studio Tecnico Sviluppo e Ricerche - www.stsr.it

TECHNICAL CHARACTERISTICS:

The line is equipped with ceramic cartridge Ø 35 mm, produced by S.T.S.R. - Research & Development Technical Office. www.stsr.it



B 10

Miscelatore monocomando per lavabo con scarico.
Single-lever basin mixer with pop-up waste.

B 11

Miscelatore monocomando per lavabo senza scarico.
Single-lever basin mixer without pop-up waste.



B 20

Miscelatore monocomando per bidet con aeratore direzionabile e con scarico.
Single-lever bidet mixer with adjustable aerator and pop-up waste.

B 21

Miscelatore monocomando per bidet con aeratore direzionabile e senza scarico.
Single-lever bidet mixer with adjustable aerator, without pop-up waste.



B 05
Miscelatore monocomando per vasca, esterno, senza doccia.
Single-lever bath mixer without shower.



B 02
Miscelatore monocomando per vasca, esterno, con doccia duplex.
Single-lever bath mixer with duplex shower.



B 08 UK
Miscelatore monocomando per vasca, esterno, su colonnette, con doccia duplex.
Single-lever bath mixer, external, on columns, with duplex shower.



B 07
Miscelatore monocomando bordo vasca serie Blue, con bocca pesante fusa con deviatore e doccetta Blue in ottone cromato.
Single lever deck bath/shower mixer serie Blue with heavy casted spout with diverter and Blue handshower in cp brass.



B 30
Miscelatore monocomando da incasso per doccia.
Built-in shower single-lever mixer.



B 09
Miscelatore monocomando da incasso con deviatore per vasca/doccia.
Built-in bath/shower single-lever mixer with diverter.





B 39
Miscelatore monocomando esterno per doccia, con doccia duplex.
Wall mounted single-lever shower mixer, with duplex shower.



B 31
Miscelatore monocomando esterno per doccia.
Wall mounted single-lever shower mixer.



B 41
Miscelatore monocomando per lavello a muro, con bocca girevole.
Single-lever wall mounted sink mixer, movable spout.



B 40
Miscelatore monocomando per lavello, con bocca girevole.
Single-lever one-hole sink mixer, movable spout.





PROJECT

La linea Project è caratterizzata da un design deciso ed attuale, adatto a vestire ambienti bagno dal gusto contemporaneo.

La particolarità della linea trova la sua massima espressione nel design del miscelatore lavabo che, rispetto agli standard di altre linee simili ed alla media di questa fascia di prodotti, si presenta molto più alto, slanciato ed anche allungato nella bocca di erogazione per gestire le esigenze di pieno comfort.

The line Project is characterized by a strong and actual design, suitable to dress bathrooms with a contemporary taste.

The peculiarity of the line finds its highest expression in the design of the washbasin mixer that is higher, slender and also elongated in the spout compared to the standards of other similar lines and to the average of this range of products, in order to give greater comfort.



CARATTERISTICHE TECNICHE:

La serie è dotata di cartuccia a dischi ceramici Ø 40 mm, prodotta da S.T.S.R. - Studio Tecnico Sviluppo e Ricerche - www.stsr.it.

Finiture disponibili: cromo, cromo oro.

TECHNICAL CHARACTERISTICS:

The series is equipped with ceramic cartridge, Ø 40 mm, produced by S.T.S.R. - Research Development Technical Office - www.stsr.it.

Available finishes: chrome, chrome gold.



P 10

Miscelatore monocomando per lavabo, con scarico.
Single-lever basin mixer with pop-up waste.



P 11

Miscelatore monocomando per lavabo, senza scarico.
Single-lever basin mixer without pop-up waste.



P 20

Miscelatore monocomando per bidet, con aeratore direzionabile e con scarico.
Single-lever bidet mixer with adjustable aerator and pop-up waste.



P 21

Miscelatore monocomando per bidet, con aeratore direzionabile e senza scarico.
Single-lever bidet mixer with adjustable aerator and without pop-up waste.

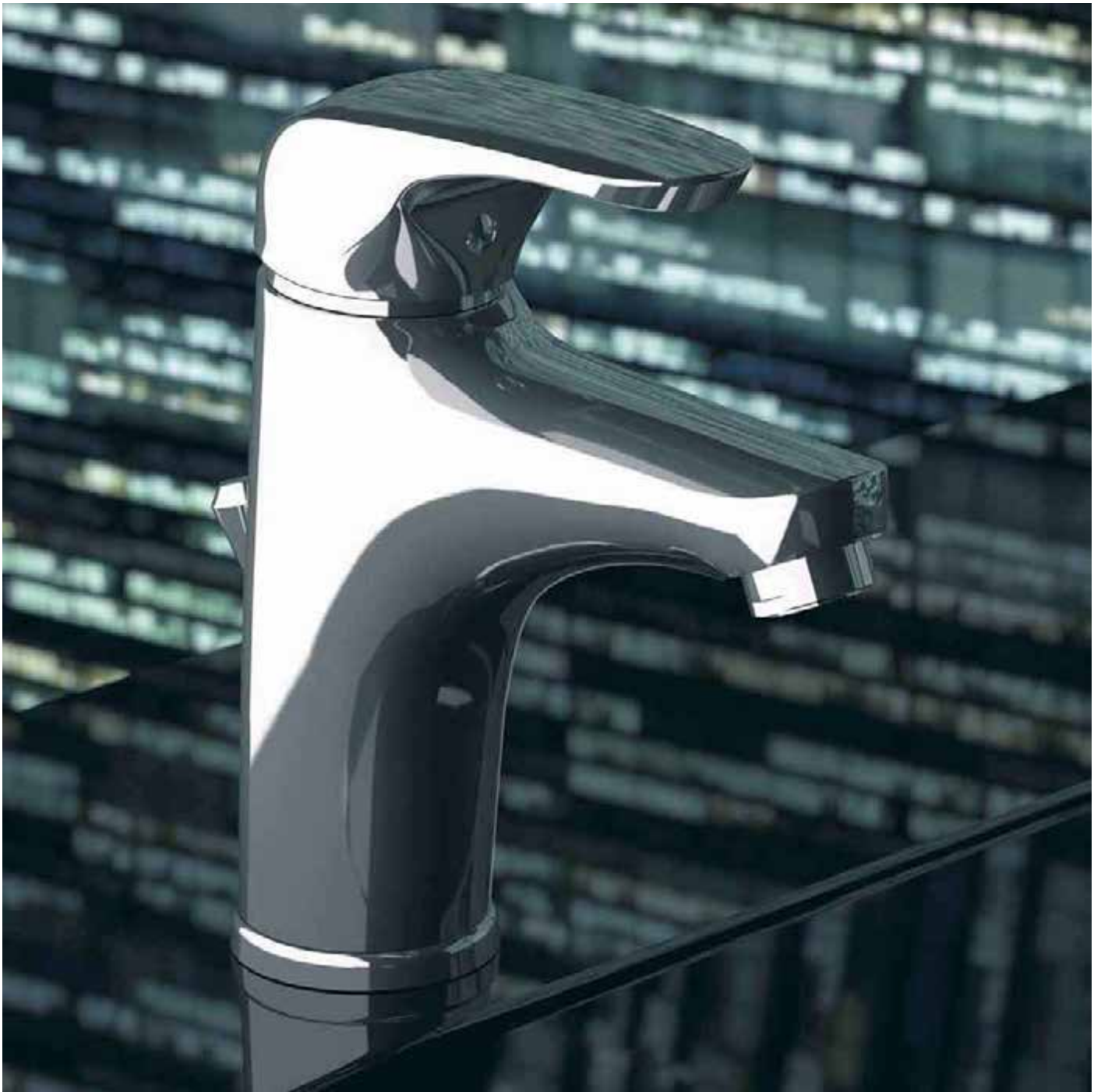

PROJECT



P 02

Miscelatore monocomando per vasca, esterno, con doccia duplex.
Single-lever bath mixer with duplex shower.



P 05

Miscelatore monocomando per vasca, esterno, senza kit doccia.
Single-lever bath mixer without shower set.



P 07

Miscelatore monocomando bordo vasca con deviatore, bocca pesante fusa e doccetta idromassaggio e anticalcare a 4 funzioni.

Single lever deck bath/shower mixer with diverter, with heavy casted spout and hydro massage, anti-limestone hand shower 4 functions.



P 07 UF

Miscelatore monocomando bordo vasca con deviatore, bocca pesante fusa con effetto a cascata e doccetta idromassaggio e anticalcare a 4 funzioni.

Single lever deck bath/shower mixer with diverter, with heavy casted spout waterfall effect and hydro massage, anti-limestone hand shower 4 functions.



P 03

Miscelatore monoforo lavabo/vasca con deviatore integrato e kit doccia.
Single-lever one-hole sink or bath mixer with diverter and shower set.



P 04

Come P 03 senza set doccia.
As P 03 without shower kit.





91
Bocca incasso per miscelatore vasca-doccia.
Built-in spout for bath-shower mixer.



91 D
Bocca incasso vasca-doccia, con deviatore integrato.
Built-in spout for bath-shower, with diverter.



P 30
Miscelatore monocomando da incasso per doccia.
Built-in shower single-lever mixer.



P 09
Miscelatore monocomando da incasso con deviatore per vasca/ doccia.
Built-in bath/shower single-lever mixer with diverter.



P 33
Miscelatore monocomando esterno per doccia con leva frontale.
Wall mounted single-lever shower mixer, with frontal lever.



P 38
Miscelatore monocomando esterno per doccia, con doccia duplex e leva frontale.
Wall mounted single-lever shower mixer, with duplex shower and frontal lever.



P 39

Miscelatore monocomando esterno per doccia, con doccia duplex.
Wall mounted single-lever shower mixer, with duplex shower.



P 31

Miscelatore monocomando esterno per doccia.
Wall mounted single-lever shower mixer.

311 D 312

Saliscendi cromato con asta tonda e doccetta anticalcare.
C.P. sliding rail set with swiveling rail and C.P. handshower
anti-limestone.



P 46

Miscelatore lavabo/vasca con canna fusa lunga 30 cm e deviatore
senza kit doccia.

Wall basin/bath single lever mixer with 30 cm long casted spout
with diverter without duplex shower.



P 49

Miscelatore lavabo/vasca con canna fusa lunga 30 cm e deviatore
con kit doccia.

Wall basin/bath single lever mixer with 30 cm long casted spout
with diverter with duplex shower.

PROJECT



P 41
Miscelatore monocomando per lavello a muro, con bocca girevole.
Single-lever wall mounted sink mixer, with movable spout.



P 41 S
Miscelatore monocomando per lavello a muro, con bocca a "S" girevole.
Single-lever wall mounted sink mixer, with "S" movable spout.



P 40
Miscelatore monocomando per lavello, con bocca girevole.
Single-lever one-hole sink mixer, with movable spout.



P 47
Miscelatore monocomando per lavello, con doccia estraibile a getto variabile.
Single-lever one-hole sink mixer, with pull-out spray jet shower, 2 functions.



P 42
Miscelatore monocomando per lavello, con bocca alta a "C" girevole, tipo lusso.
Single-lever one-hole sink mixer, with "C" high movable spout, luxury type.



P 42 C
Miscelatore monocomando per lavello, con bocca alta a "C" girevole, tipo lusso, modello corto.
Single-lever one-hole sink mixer, with "C" high movable spout, luxury type, shorter model.



P 42 U

Miscelatore monocomando per lavello, con bocca alta a "U" girevole.
Single-lever one-hole sink mixer, with high "U" movable spout.



P 42 R

Miscelatore monocomando per lavello, con bocca alta girevole, tipo lusso.
Single-lever one-hole sink mixer, with high movable spout, luxury type.



P 43

Miscelatore monocomando per lavello a muro, con leva frontale e bocca alta girevole.

Single-lever wall mounted sink mixer, with frontal lever and high movable spout.



P 43 C

Miscelatore monocomando per lavello a muro, con leva frontale e bocca alta girevole, bocca modello corto.

Single-lever wall mounted sink mixer, with frontal lever and high movable spout, shorter movable spout.





T E N

La linea Ten rappresenta la classica espressione del monocomando contemporaneo cogliendo perfettamente il gusto moderno, l'esigenza di solidità e di grande portata d'acqua e la praticità d'uso. Ten è quindi una linea molto attuale e dal design che si colloca perfettamente sia in ambienti classici che contemporanei.

The line Ten represents the classical expression of the contemporary single-lever mixer, perfectly capturing the modern taste, the need of stability, high water flow and practicality of use. Ten is therefore a very actual line and with a design that fits perfectly both in classic and contemporary rooms.

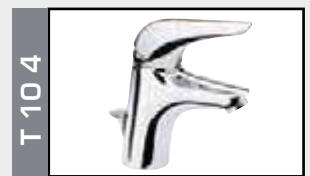
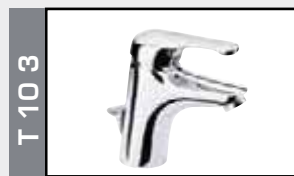
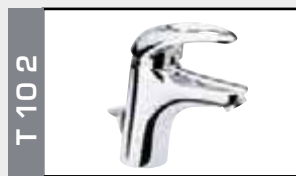

CARATTERISTICHE TECNICHE:

La serie è dotata di cartuccia a dischi ceramici Ø 40 mm, prodotta da S.T.S.R. - Studio Tecnico Sviluppo e Ricerche - www.stsr.it.

Finiture disponibili: cromo, cromo oro.

TECHNICAL CHARACTERISTICS:

The series is equipped with ceramic cartridge, Ø 40 mm, produced by S.T.S.R. - Research Development Technical Office - www.stsr.it.

Available finishes: chrome, chrome gold, white.



T 10

Miscelatore monocomando per lavabo, con scarico.
Single-lever basin mixer with pop-up waste.

T 11

Miscelatore monocomando per lavabo, senza scarico.
Single-lever basin mixer without pop-up waste.



T 20

Miscelatore monocomando per bidet, con aeratore direzionabile e con scarico.

Single-lever bidet mixer with adjustable aerator and pop-up waste.

T 21

Miscelatore monocomando per bidet, con aeratore direzionabile e senza scarico.

Single-lever bidet mixer with adjustable aerator and without pop-up waste.



T 05

Miscelatore monocomando per vasca, esterno, senza kit doccia.
Single-lever bath mixer without shower set.



T 02

Miscelatore monocomando per vasca, esterno, con doccia duplex.
Single-lever bath mixer with duplex shower.



T 07

Miscelatore monocomando bordo vasca con deviatore, bocca pesante fusa e doccetta idromassaggio e anticalcare a 4 funzioni.

Single lever deck bath/shower mixer with diverter, with heavy casted spout and hydro massage, anti-limestone hand shower 4 functions.



T 07 UF

Miscelatore monocomando bordo vasca con deviatore, bocca pesante fusa con effetto a cascata e doccetta idromassaggio e anticalcare a 4 funzioni.

Single lever deck bath/shower mixer with diverter, with heavy casted spout waterfall effect and hydro massage, anti-limestone hand shower 4 functions.



T 04

Come T 03 senza set doccia.
As T 03 without shower kit.



T 03

Miscelatore monoforo lavabo/vasca con deviatore integrato e kit doccia.
Single-lever one-hole sink or bath mixer with diverter and shower set.



T 30

Miscelatore monocomando da incasso per doccia.
Built-in shower single-lever mixer.



T 09

Miscelatore monocomando da incasso con deviatore per vasca/doccia.
Built-in bath/shower single-lever mixer with diverter.



311 D 312

Saliscendi cromato con asta tonda e doccetta anticalcare.
C.P. sliding rail set with swiveling rail and C.P. handshower anti-limestone.



91

Bocca incasso per miscelatore vasca-doccia.
Built-in spout for bath-shower mixer.



91 D

Bocca incasso vasca-doccia, con deviatore integrato.
Built-in spout for bath-shower, with diverter.



T 33

Miscelatore monocomando esterno per doccia con leva frontale.
Wall mounted single-lever shower mixer, with frontal lever.



T 38

Miscelatore monocomando esterno per doccia, con doccia duplex e leva frontale.

Wall mounted single-lever shower mixer, with duplex shower and frontal lever.



T 31

Miscelatore monocomando esterno per doccia.
Wall mounted single-lever shower mixer.



T 39

Miscelatore monocomando esterno per doccia, con doccia duplex.
Wall mounted single-lever shower mixer, with duplex shower.



T 46

Miscelatore lavabo/vasca con canna fusa lunga 30 cm e deviatore senza kit doccia.

Wall basin/bath single lever mixer with 30 cm long casted spout with diverter without duplex shower.



T 49

Miscelatore lavabo/vasca con canna fusa lunga 30 cm e deviatore con kit doccia.

Wall basin/bath single lever mixer with 30 cm long casted spout with diverter with duplex shower.



T 41

Miscelatore monocomando per lavello a muro, con bocca girevole.
Single-lever wall mounted sink mixer, with movable spout.



T 41 S

Miscelatore monocomando per lavello a muro, con bocca a "S" girevole.
Single-lever wall mounted sink mixer, with "S" movable spout.



T 40

Miscelatore monocomando per lavello, con bocca girevole.
Single-lever one-hole sink mixer, with movable spout.



T 47

Miscelatore monocomando per lavello, con doccia estraibile a getto variabile.
Single-lever one-hole sink mixer, with pull-out spray jet shower, 2 functions.



T 42

Miscelatore monocomando per lavello, con bocca alta girevole, tipo lusso.
Single-lever one-hole sink mixer, with high movable spout, luxury type.



T 42 C

Miscelatore monocomando per lavello, con bocca alta girevole, modello corto, tipo lusso.
Single-lever one-hole sink mixer, with high movable spout, luxury type, shorter model.

Single-lever one-hole sink mixer, with high movable spout, luxury type, shorter model.



T 42 U

Miscelatore monocomando per lavello, con bocca alta a "U" girevole.
Single-lever one-hole sink mixer, with high "U" movable spout.



T 42 R

Miscelatore monocomando per lavello, con bocca alta girevole, tipo lusso.
Single-lever one-hole sink mixer, with high movable spout, luxury type.



T 43

Miscelatore monocomando per lavello a muro, con leva frontale e bocca alta girevole.
Single-lever wall mounted sink mixer, with frontal lever and high movable spout.



T 43 C

Miscelatore monocomando per lavello a muro, con leva frontale e bocca alta girevole, bocca modello corto.
Single-lever wall mounted sink mixer, with frontal lever and high movable spout, shorter movable spout.



G I G A

La serie di miscelatori monocomando Giga si qualifica per la ricerca di solidità nel design che si traduce in un prodotto dall'aspetto importante garantito da un miscelatore lavabo con bocca di erogazione più lunga della media, per garantire maggiore comfort, e dalle linee squadrate ed imponenti. Tutta la serie Giga segue la filosofia estetico - costruttiva del lavabo e la grande portata è garantita dall'uso della cartuccia da 40mm.

The line of Giga single-lever mixers qualifies for the research of stability in the design resulting in a product with an important appearance ensured by the single-lever wash basin mixer with a spout longer than average, in order to give greater comfort, and by the squared and impressive lines. All the Giga series follows the aesthetic-constructive philosophy of the basin and the large flow is guaranteed by the use of the 40mm cartridge.





CARATTERISTICHE TECNICHE:

La serie è dotata di cartuccia a dischi Ø 40 mm, prodotta da S.T.S.R. - Studio Tecnico Sviluppo e Ricerche - www.stsr.it.

Finiture disponibili: cromo, cromo oro.

TECHNICAL CHARACTERISTICS:

The series is equipped with ceramic cartridge, Ø 40 mm, produced by S.T.S.R. - Research Development Technical Office - www.stsr.it.

Available finishes: chrome, chrome gold.



G 10

Miscelatore monocomando per lavabo, con scarico.
Single-lever basin mixer with pop-up waste.

G 11

Miscelatore monocomando per lavabo, senza scarico.
Single-lever basin mixer without pop-up waste.



G 22

Miscelatore monocomando bidet con deviatore per bocca e doccia.
Single lever bidet mixer with diverter for spout and spray.



G 20

Miscelatore monocomando per bidet, con aeratore direzionabile e con scarico.
Single-lever bidet mixer with adjustable aerator and pop-up waste.

Single-lever bidet mixer with adjustable aerator and pop-up waste.

G 21

Miscelatore monocomando per bidet, con aeratore direzionabile e senza scarico.
Single-lever bidet mixer with adjustable aerator and without pop-up waste.

Single-lever bidet mixer with adjustable aerator and without pop-up waste.



G 05

Miscelatore monocomando per vasca, esterno, senza doccia.
Single-lever bath mixer without shower.



G 02

Miscelatore monocomando per vasca, esterno, con doccia duplex.
Single-lever bath mixer with duplex shower.



G 07

Miscelatore monocomando bordo vasca serie Giga con deviatore, bocca pesante fusa e doccetta idromassaggio e anticalcare a 4 funzioni.

Single lever deck bath/shower mixer serie Giga with diverter, with heavy casted spout and hydro massage, anti-limestone hand shower 4 functions.



G 07 UF

Miscelatore monocomando bordo vasca con deviatore, bocca pesante fusa con effetto a cascata e doccetta idromassaggio e anticalcare a 4 funzioni.

Single lever deck bath/shower mixer with diverter, with heavy casted spout waterfall effect and hydro massage, anti-limestone hand shower 4 functions.



G 03

Miscelatore monoforo lavabo / vasca con deviatore integrato e kit doccia.
Single-lever one-hole sink or bath mixer with diverter and shower set.



G 04

Come G 03 senza set doccia.
As G 03 without shower kit.



91
Bocca incasso per miscelatore vasca-doccia.
Built-in spout for bath-shower mixer.



91 D
Bocca incasso vasca-doccia, con deviatore integrato.
Built-in spout for bath-shower, with diverter.



311F 311DA
Saliscendi cromato con asta tonda e doccetta anticalcare.
C.P. sliding rail set swiveling rail c.p. handshower with anti-limestone.



G 30
Miscelatore monocomando da incasso per doccia.
Built-in shower single-lever mixer.



G 09
Miscelatore monocomando da incasso con deviatore per vasca/ doccia.
Built-in bath/shower single-lever mixer with diverter.



G 38

Miscelatore monocomando esterno per doccia, con doccia duplex e leva frontale.

Wall mounted single-lever shower mixer, with duplex shower and frontal lever.



G 33

Miscelatore monocomando esterno per doccia con leva frontale.

Wall mounted single-lever shower mixer with frontal lever.



G 39

Miscelatore monocomando esterno per doccia, con doccia duplex.

Wall mounted single-lever shower mixer, with duplex shower.



G 31

Miscelatore monocomando esterno per doccia.

Wall mounted single-lever shower mixer.







G 40
Miscelatore monocomando per lavello, con bocca girevole.
Single-lever one-hole sink mixer, with movable spout.



G 47
Miscelatore monocomando per lavello, con doccia estraibile a getto variabile.

Single-lever one-hole sink mixer, with pull-out spray jet shower, 2 functions.



G 42
Miscelatore monocomando per lavello, con bocca alta girevole, tipo lusso.
Single-lever one-hole sink mixer, with movable spout.



G 42 C
Miscelatore monocomando per lavello, con bocca alta girevole, modello corto, tipo lusso.

Single-lever one-hole sink mixer, with high movable spout, luxury type, shorter model.



G 42 U
Miscelatore monocomando per lavello, con bocca alta a "U" girevole.
Single-lever one-hole sink mixer, with high "U" movable spout.



G 42 R
Miscelatore monocomando per lavello, con bocca alta girevole, tipo lusso.
Single-lever one-hole sink mixer, with high movable spout, luxury type.



G 43

Miscelatore monocomando per lavello a muro, con leva frontale e bocca alta girevole.

Single-lever wall mounted sink mixer, with frontal lever and high movable spout.



G 43 C

Miscelatore monocomando per lavello a muro, con leva frontale e bocca alta girevole, bocca modello corto.

Single-lever wall mounted sink mixer, with frontal lever and high movable spout, shorter movable spout.



G 41

Miscelatore monocomando per lavello a muro, con bocca girevole.

Single-lever wall mounted sink mixer, with movable spout.



G 41 S

Miscelatore monocomando per lavello a muro, con bocca a "S" girevole.

Single-lever wall mounted sink mixer, with "S" movable spout.



G 46

Miscelatore lavabo/vasca con canna fusa lunga 30 cm e deviatore senza kit doccia.

Wall basin/bath single lever mixer with 30 cm long casted spout with diverter without duplex shower.



G 49

Miscelatore lavabo/vasca con canna fusa lunga 30 cm e deviatore con kit doccia.

Wall basin/bath single lever mixer with 30 cm long casted spout with diverter with duplex shower.



GIGA FOUR

La serie di miscelatori monocomando Giga si qualifica per la ricerca di solidità nel design che si traduce in un prodotto dall'aspetto importante garantito da un miscelatore lavabo con bocca di erogazione più lunga della media, per garantire maggiore comfort, e dalle linee squadrate ed imponenti. Tutta la serie Giga segue la filosofia estetico - costruttiva del lavabo e la grande portata è garantita dall'uso della cartuccia da 40mm.

The line of Giga single-lever mixers qualifies for the research of stability in the design resulting in a product with an important appearance ensured by the single-lever wash basin mixer with a spout longer than average, in order to give greater comfort, and by the squared and impressive lines. All the Giga series follows the aesthetic-constructive philosophy of the basin and the large flow is guaranteed by the use of the 40mm cartridge.





CARATTERISTICHE TECNICHE:

La serie è dotata di cartuccia a dischi ceramici Ø 40 mm, prodotta da S.T.S.R. - Studio Tecnico Sviluppo e Ricerche - www.stsr.it.

Finiture disponibili: cromo, cromo oro.

TECHNICAL CHARACTERISTICS:

The series is equipped with ceramic cartridge, Ø 40 mm, produced by S.T.S.R. - Research Development Technical Office - www.stsr.it.

Available finishes: chrome, chrome gold.



G 10 4

Miscelatore monocomando per lavabo, con scarico.
Single-lever basin mixer with pop-up waste.



G 11 4

Miscelatore monocomando per lavabo, senza scarico.
Single-lever basin mixer without pop-up waste.



G 20 4

Miscelatore monocomando per bidet, con scarico.
Single-lever bidet mixer with adjustable aerator and pop-up waste.



G 22 4

Miscelatore monocomando bidet con deviatore per bocca e doccia.
Single lever bidet mixer with diverter for spout and spray.

G 21 4

Miscelatore monocomando per bidet, senza scarico.
Single-lever bidet mixer without adjustable aerator and pop-up waste.

**G 05 4**

Miscelatore monocomando per vasca, esterno, senza kit doccia.
Single-lever bath mixer without shower set.

**G 02 4**

Miscelatore monocomando per vasca, esterno, con doccia duplex.
Single-lever bath mixer with duplex shower.

**G 07 4**

Miscelatore monocomando bordo vasca serie Giga con deviatore, bocca pesante fusa e doccetta idromassaggio e anticalcare a 4 funzioni.

Single lever deck bath/shower mixer serie Giga with diverter, with heavy casted spout and hydro massage, anti-limestone hand shower 4 functions.

**G 07 UF 4**

Miscelatore monocomando bordo vasca con deviatore, bocca pesante fusa con effetto a cascata e doccetta idromassaggio e anticalcare a 4 funzioni.

Single lever deck bath/shower mixer with diverter, with heavy casted spout waterfall effect and hydro massage, anti-limestone hand shower 4 functions.

**G 03 4**

Miscelatore monoforo lavabo / vasca con deviatore integrato e kit doccia.
Single-lever one-hole sink or bath mixer with diverter and shower set.

**G 04 4**

Come G 03 4 senza kit doccia.
As G 03 4 without shower set.

GIGA FOUR



91

Bocca incasso per miscelatore vasca-doccia.
Built-in spout for bath-shower mixer.



91 D

Bocca incasso vasca-doccia, con deviatore integrato.
Built-in spout for bath-shower, with diverter.



G 30 4

Miscelatore monocomando da incasso per doccia.
Built-in shower single-lever mixer.



G 09 4

Miscelatore monocomando da incasso con deviatore per vasca/doccia.
Built-in bath/shower single-lever mixer with diverter.



311F 311M

Saliscendi cromato con asta tonda e doccetta anticalcare.
C.P. sliding rail set swiveling rail c.p. handshower with anti-limestone.



G 38 4

Miscelatore monocomando esterno per doccia, con doccia duplex.
Wall mounted single-lever shower mixer, with duplex shower.

G 33 4

Miscelatore monocomando esterno per doccia con leva frontale.
Wall mounted single-lever shower mixer with frontal lever.



G 39 4

Miscelatore monocomando esterno per doccia, con doccia duplex.
Wall mounted single-lever shower mixer, with duplex shower.

G 31 4

Miscelatore monocomando esterno per doccia, senza kit doccia.
Wall mounted single-lever shower mixer, without shower set.



GIGA FOUR



G 40 4

Miscelatore monocomando per lavello, con bocca girevole.
Single-lever one-hole sink mixer, with movable spout.

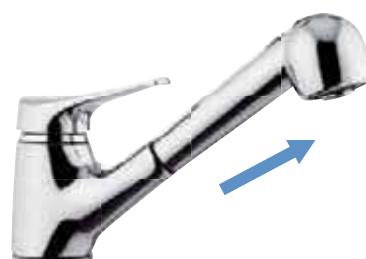

G 47 4

Miscelatore monocomando per lavello, con doccia estraibile a getto variabile.
Single-lever one-hole sink mixer, with pull-out spray jet shower, 2 functions.

Single-lever one-hole sink mixer, with pull-out spray jet shower, 2 functions.



G 42 4

Miscelatore monocomando per lavello, con bocca alta girevole, tipo lusso.
Single-lever one-hole sink mixer, with high movable spout, luxury type.



G 42 C 4

Miscelatore monocomando per lavello, con bocca alta girevole, modello corto, tipo lusso.
Single-lever one-hole sink mixer, with high movable spout, luxury type, shorter model.

Single-lever one-hole sink mixer, with high movable spout, luxury type, shorter model.



G 42 U 4

Miscelatore monocomando per lavello, con bocca alta a "U" girevole.
Single-lever one-hole sink mixer, with high "U" movable spout.



G 42 R 4

Miscelatore monocomando per lavello, con bocca alta girevole, tipo lusso.
Single-lever one-hole sink mixer, with high movable spout, luxury type.



G 43 4

Miscelatore monocomando per lavello a muro, con leva frontale e bocca alta girevole.

Single-lever wall mounted sink mixer, with frontal lever and high movable spout.



G 43 C 4

Miscelatore monocomando per lavello a muro, con leva frontale e bocca alta girevole, bocca modello corto.

Single-lever wall mounted sink mixer, with frontal lever and high movable spout, shorter movable spout.



G 41 4

Miscelatore monocomando per lavello a muro, con bocca girevole.

Single-lever wall mounted sink mixer, with movable spout.



G 41 S 4

Miscelatore monocomando per lavello a muro, con bocca a "S" girevole.

Single-lever wall mounted sink mixer, with "S" movable spout.



G 46 4

Miscelatore lavabo/vasca con canna fusa lunga 30 cm e deviatore senza kit doccia.

Wall basin/bath single lever mixer with 30 cm long casted spout with diverter without duplex shower.



G 49 4

Miscelatore lavabo/vasca con canna fusa lunga 30 cm e deviatore con kit doccia.

Wall basin/bath single lever mixer with 30 cm long casted spout with diverter with duplex shower.



MUSA

Una serie di miscelatori monocomando caratterizzata da uno stile più classico ed adatta a vestire ambienti dal gusto tradizionale, country e romantico, che non vogliono perdere la praticità del comando a leva. Le linee sinuose ed arrotondate che corrono lungo tutto il corpo sono accompagnate perfettamente della linea della leva che definisce completamente lo stile in piena armonia.

A series of single-lever mixers characterized by a more classical style and suitable to dress rooms of traditional, romantic and country taste, which do not want to lose the practicality of the lever-handle. The curving and rounded lines that run all along the body are perfectly accompanied by the line of the lever that completely defines the style in full harmony.





CARATTERISTICHE TECNICHE:

La serie è dotata di cartuccia a dischi ceramici Ø 40 mm, prodotta da S.T.S.R. - Studio Tecnico Sviluppo e Ricerche - www.stsr.it.

Finiture disponibili: cromo, cromo oro, bianco lucido.

TECHNICAL CHARACTERISTICS:

The series is equipped with ceramic cartridge, Ø 40 mm, produced by S.T.S.R. - Research Development Technical Office - www.stsr.it.

Available finishes: chrome, chrome gold, shiny white.



M 10

Miscelatore monocomando per lavabo, con scarico.
Single-lever basin mixer with pop-up waste.

M 11

Miscelatore monocomando per lavabo, senza scarico.
Single-lever basin mixer without pop-up waste.



M 20

Miscelatore monocomando per bidet, con aeratore direzionabile e con scarico.

Single-lever bidet mixer with adjustable aerator and pop-up waste.

M 21

Miscelatore monocomando per bidet, con aeratore direzionabile e senza scarico.

Single-lever bidet mixer with adjustable aerator and without pop-up waste.



M 02

Miscelatore monocomando per vasca, esterno, con doccia duplex, a 4 funzioni.

Single-lever bath mixer with duplex shower, 4 functions.



M 05

Miscelatore monocomando per vasca, esterno, senza kit doccia.

Single-lever bath mixer without shower set.



M 07

Miscelatore monocomando bordo vasca serie Musa con deviatore, bocca pesante fusa e doccetta idromassaggio e anticalcare a 4 funzioni.

Single lever deck bath/shower mixer serie Musa with diverter, with heavy casted spout and hydro massage, anti-limestone hand shower 4 functions.



M 07 UF

Miscelatore monocomando bordo vasca con deviatore, bocca pesante fusa con effetto a cascata e doccetta idromassaggio e anticalcare a 4 funzioni.

Single lever deck bath/shower mixer with diverter, with heavy casted spout waterfall effect and hydro massage, anti-limestone hand shower 4 functions.



M 03

Miscelatore monoforo lavabo/vasca con deviatore integrato e kit doccia a 4 funzioni.

Single-lever one-hole sink or bath mixer with diverter and 4 functions shower set.



M 04

Come M 03 senza kit doccia.

As M 03 without shower set.



M 08 UK

Miscelatore monocomando per vasca, esterno, su colonnette, con doccia duplex a 4 funzioni.

Single-lever bath mixer, external, on columns, with 4 functions duplex shower.







91

Bocca incasso per miscelatore vasca-doccia.
Built-in spout for bath-shower mixer.



91 D

Bocca incasso vasca-doccia, con deviatore integrato.
Built-in spout for bath-shower, with diverter.



310 317

Saliscendi cromato con asta tonda e doccetta anticalcare a 4 funzioni.
Sliding rail set with round rod and C.P. handshower anti-limestone,
4 functions.



M 30

Miscelatore monocomando da incasso per doccia.
Built-in shower single-lever mixer.



M 09

Miscelatore monocomando da incasso con deviatore per vasca/doccia.
Built-in bath/shower single-lever mixer with diverter.



M 33

Miscelatore monocomando esterno per doccia con leva frontale.

Wall mounted single-lever shower mixer with frontal lever.



M 38

Miscelatore monocomando esterno per doccia, con leva frontale e doccia duplex a 4 funzioni.

Wall mounted single-lever shower mixer, with frontal lever and 4 functions duplex shower.



M 31

Miscelatore monocomando esterno per doccia.

Wall mounted single-lever shower mixer.



M 39

Miscelatore monocomando esterno per doccia, con doccia duplex 4 funzioni.

Wall mounted single-lever shower mixer, with 4 functions duplex shower.



M 40

Miscelatore monocomando per lavello, con bocca girevole.
Single-lever one-hole sink mixer, with movable spout.



M 47

Miscelatore monocomando per lavello, con doccia estraibile a getto variabile.
Single-lever one-hole sink mixer, with pull-out spray jet shower, 2 functions.

Single-lever one-hole sink mixer, with pull-out spray jet shower, 2 functions.



M 42

Miscelatore monocomando per lavello, con bocca alta girevole.
Single-lever one-hole sink mixer, with high movable spout.



M 42 C

Miscelatore monocomando per lavello, con bocca alta girevole, modello corto, tipo lusso.
Single-lever one-hole sink mixer, with high movable spout, luxury type, shorter model.

Single-lever one-hole sink mixer, with high movable spout, luxury type, shorter model.



M 42 U

Miscelatore monocomando per lavello, con bocca alta a "U" girevole.
Single-lever one-hole sink mixer, with high "U" movable spout.



M 42 R

Miscelatore monocomando per lavello, con bocca alta girevole, tipo lusso.
Single-lever one-hole sink mixer, with high movable spout, luxury type.



M 43

Miscelatore monocomando per lavello a muro, con leva frontale e bocca alta girevole.

Single-lever wall mounted sink mixer, with frontal lever and high movable spout.



M 43 C

Miscelatore monocomando per lavello a muro, con leva frontale e bocca alta girevole, bocca modello corto.

Single-lever wall mounted sink mixer, with frontal lever and high movable spout, shorter movable spout.



M 41

Miscelatore monocomando per lavello a muro, con bocca girevole.

Single-lever wall mounted sink mixer, with movable spout.



M 41 S

Miscelatore monocomando per lavello a muro, con bocca a "S" girevole.

Single-lever wall mounted sink mixer, with "S" movable spout.



M 46

Miscelatore lavabo/vasca con canna fusa lunga 30 cm e deviatore senza kit doccia.

Wall basin/bath single lever mixer with 30 cm long casted spout with diverter without duplex shower.



M 49

Miscelatore lavabo/vasca con canna fusa lunga 30 cm e deviatore con kit doccia 4 funzioni.

Wall basin/bath single lever mixer with 30 cm long casted spout with diverter with 4 functions duplex shower.



KISS

La serie di miscelatori monocomando Kiss segue un design semplice e funzionale, mantenendo comunque degli standard di portata elevati grazie all'uso di cartuccia Ø 40. Questa serie si adatta bene ad ambienti classici e contemporanei, e le caratteristiche di praticità insieme all'ampia gamma in produzione, riescono spesso a risolvere, pur nella semplicità degli oggetti, molte esigenze funzionali.

The series of Kiss single-lever mixers follows a simple and functional design, while maintaining high flow standards thanks to the use of a 40mm diameter cartridge. This series well suites to classic and contemporary environment, and the features of practicality convenience together with the wide range in production can often solve, despite the simplicity of the objects, many functional requirements.





CARATTERISTICHE TECNICHE:

La serie è dotata di cartuccia a dischi ceramici Ø 40 mm, prodotta da S.T.S.R. - Studio Tecnico Sviluppo e Ricerche - www.stsr.it.

Finiture disponibili: cromo, cromo oro.

TECHNICAL CHARACTERISTICS:

The series is equipped with ceramic cartridge, Ø 40 mm, produced by S.T.S.R. - Research Development Technical Office - www.stsr.it.

Available finishes: chrome, chrome gold.



K 10

Miscelatore monocomando per lavabo, con scarico.
Single-lever basin mixer with pop-up waste.

K 11

Miscelatore monocomando per lavabo, senza scarico.
Single-lever basin mixer without pop-up waste.

K 10 P

Miscelatore monocomando per lavabo, con scarico in plastica.
Single-lever basin mixer with plastic pop-up waste.



K 10 L

Miscelatore monocomando per lavabo, con bocca lunga e scarico.
Single-lever basin mixer with long spout and pop-up waste.

K 11 L

Miscelatore monocomando per lavabo, con bocca lunga e senza scarico.
Single-lever basin mixer with long spout and without pop-up waste.

K 10 LP

Miscelatore monocomando per lavabo, con bocca lunga e scarico in plastica.
Single-lever basin mixer with long spout and plastic pop-up waste.



K 11 G

Miscelatore monocomando per lavabo o lavello, con bocca girevole.
Single-lever one-hole basin or sink mixer, with movable spout.



K 22

Miscelatore monocomando bidet con deviatore per bocca e doccetta.
Single lever bidet mixer with diverter for spout and spray.



K 20

Miscelatore monocomando per bidet, con aeratore direzionabile e scarico.
Single-lever bidet mixer with adjustable aerator and pop-up waste.

Single-lever bidet mixer with adjustable aerator and pop-up waste.

K 20 P

Miscelatore monocomando per bidet, con aeratore direzionabile e scarico in plastica.
Single-lever bidet mixer with adjustable aerator and plastic pop-up waste.

Single-lever bidet mixer with adjustable aerator and plastic pop-up waste.



K 21

Miscelatore monocomando per bidet, con aeratore direzionabile, senza scarico.
Single-lever bidet mixer with adjustable aerator and without pop-up waste.

Single-lever bidet mixer with adjustable aerator and without pop-up waste.



K 23

Miscelatore monocomando per bidet, con doccetta.
Single-lever bidet mixer with spray.



K 24

Miscelatore monocomando per bidet, con deviatore e doccetta.
Single-lever bidet mixer with diverter and spray.





K 02

Miscelatore monocomando per vasca, esterno, con doccia duplex.
Single-lever bath mixer with duplex shower.



K 05

Miscelatore monocomando per vasca, esterno, senza kit doccia.
Single-lever bath mixer without shower set.



K 08 UK

Miscelatore monocomando per vasca, esterno, su colonnette, con doccia duplex.
Single lever bath mixer, external, on columns, with duplex shower.



K 01

Miscelatore monocomando per vasca senza deviatore e senza kit doccia.
Single-lever bath mixer without diverter and without shower kit.



K 07

Miscelatore monocomando bordo vasca serie Kiss con deviatore, bocca pesante fusa e doccetta idromassaggio e anticalcare a 4 funzioni.

Single lever deck bath/shower mixer serie Kiss with diverter, with heavy casted spout and hydro massage, anti-limestone hand shower 4 functions.



K 07 UF

Miscelatore monocomando bordo vasca con deviatore, bocca pesante fusa con effetto a cascata e doccetta idromassaggio e anticalcare a 4 funzioni.

Single lever deck bath/shower mixer with diverter, with heavy casted spout waterfall effect and hydro massage, anti-limestone hand shower 4 functions.



K 03

Miscelatore monoforo lavabo/vasca con deviatore integrato e kit doccia.
Single-lever one-hole sink or bath mixer with diverter and shower set.



K 04

Come K 03 senza kit doccia.
As K 03 without shower set.



91

Bocca incasso per miscelatore vasca-doccia.
Built-in spout for bath-shower mixer.



91 D

Bocca incasso vasca-doccia, con deviatore integrato.
Built-in spout for bath-shower, with diverter.



K 30

Miscelatore monocomando da incasso per doccia.
Built-in shower single-lever mixer.



K 09

Miscelatore monocomando da incasso con deviatore per vasca/doccia.
Built-in bath/shower single-lever mixer with diverter.



311 311 DA

Saliscendi con doccetta anticalcare, con getti in silicone.
Sliding rail set with anti-limestone handshower.



K 33

Miscelatore monocomando esterno per doccia con leva frontale.
Wall mounted single-lever shower mixer with frontal lever.



K 38

Miscelatore monocomando esterno per doccia, con doccia duplex e leva frontale.
Wall mounted single-lever shower mixer, with duplex shower and frontal lever.

Wall mounted single-lever shower mixer, with duplex shower and frontal lever.



K 31

Miscelatore monocomando esterno per doccia.
Wall mounted single-lever shower mixer.



K 39

Miscelatore monocomando esterno per doccia, con doccia duplex.
Wall mounted single-lever shower mixer, with duplex shower.



K 40
Miscelatore monocomando per lavello, con bocca girevole.
Single-lever one-hole sink mixer, with movable spout.



K 47
Miscelatore monocomando per lavello, con doccia estraibile a getto variabile.
Single-lever one-hole sink mixer, with pull-out spray jet shower, 2 functions.



K 42
Miscelatore monocomando per lavello, con bocca alta girevole.
Single-lever one-hole sink mixer, with high movable spout.



K 42 C
Miscelatore monocomando per lavello, con bocca alta girevole a "C", tipo lusso, modello corto.
Single-lever one-hole sink mixer, with "C" high movable spout, luxury type, shorter model.



K 42 U
Miscelatore monocomando per lavello, con bocca alta a "U" girevole.
Single-lever one-hole sink mixer, with high "U" movable spout.



K 42 R
Miscelatore monocomando per lavello, con bocca alta girevole, tipo lusso.
Single-lever one-hole sink mixer, with high movable spout, luxury type.



K 43

Miscelatore monocomando per lavello a muro, con leva frontale e bocca alta girevole.

Single-lever wall mounted sink mixer, with frontal lever and high movable spout.



K 43 C

Miscelatore monocomando per lavello a muro, con leva frontale e bocca alta girevole, bocca modello corto.

Single-lever wall mounted sink mixer, with frontal lever and high, shorter movable spout.



K 41

Miscelatore monocomando per lavello a muro, con bocca girevole.

Single-lever wall mounted sink mixer, with movable spout.



K 41 S

Miscelatore monocomando per lavello a muro, con bocca a "S" girevole.

Single-lever wall mounted sink mixer, with "S" movable spout.



K 46

Miscelatore lavabo/vasca con canna fusa lunga 30 cm e deviatore senza kit doccia.

Wall basin/bath single lever mixer with 30 cm long casted spout with diverter without duplex shower.



K 49

Miscelatore lavabo/vasca con canna fusa lunga 30 cm e deviatore con kit doccia.

Wall basin/bath single lever mixer with 30 cm long casted spout with diverter with duplex shower.



K 14

Miscelatore lavabo con scarico e leva lunga.
Wash basin mixer with pop-up waste and long lever.



K 14 L

Miscelatore lavabo con bocca lunga, scarico e leva lunga.
Wash basin mixer with long spout, pop-up waste and long lever.



K 11 G LL

Miscelatore monocomando per lavabo o lavello, con bocca girevole e leva lunga.
Single-lever one-hole basin or sink mixer, with movable spout and long lever.



K 44

Miscelatore lavello con bocca girevole e leva lunga.
Sink mixer with swivel spout and long lever.



K 42 LL

Miscelatore monocomando per lavello, con bocca alta girevole e leva lunga.
Single-lever one-hole sink mixer, with high movable spout and long lever.



K 47 LL

Miscelatore monocomando per lavello con leva lunga e doccia estraibile a getto variabile.
Single-lever one-hole sink mixer with long lever and with pull-out spray jet shower with 2 functions.



K 39 LL

Miscelatore monocomando esterno per doccia con leva lunga e doccia duplex.

External mounted shower mixer, with long lever and duplex shower.



K 31 LL

Miscelatore monocomando esterno per doccia con leva lunga.

External mounted shower mixer, with long lever.



K 45

Miscelatore monocomando per lavello a muro con leva lunga e bocca girevole.

Wall mounted single lever sink mixer with movable spout and long lever.



K 45 S

Miscelatore monocomando per lavello a muro con leva lunga e bocca a "S" girevole.

Wall mounted single lever sink mixer with movable "S" spout and long lever.



MA 14

Leva lunga per miscelatori con cartuccia diam.40.

Spare long lever for single lever mixers with cartridge diam. 40.





LINEA BASSA PRESSIONE - LOW PRESSURE LINE



K 40 BP

Miscelatore monocomando per lavello, con bocca girevole, per bassa pressione.

Single-lever one-hole sink mixer, with movable spout, for low pressure.



K 40 BPC

Miscelatore monocomando per lavabo o lavello, con bocca girevole corta, per bassa pressione.

Single-lever one-hole basin or sink mixer, with short movable spout, for low pressure.



K 41 BP

Miscelatore monocomando per lavello a muro, con bocca girevole, per bassa pressione.

Single-lever wall mounted sink mixer, with movable spout, for low pressure.



K 40 DW

Miscelatore lavello a tre vie di ingresso con bocca girevole, con selezione acqua potabile tramite la leva, con 2 aeratori in uscita.

Three ways inlet single lever sink mixer, with movable spout, with selection for drinking water directly from the lever, with 2 exit aerators.



K 40 AP

Miscelatore monocomando per lavello, con bocca girevole, con selettore per acqua potabile (tre vie di ingresso).

Single-lever one-hole sink mixer, with movable spout, with selector for drinking water (three ways inlet).

LINEA PARRUCCHIERE - HAIRDRESSER LINE



K 66

Mixer per acconciatore completo con doccia estraibile.

Barber mixer complete with pull-out shower.

LINEA MONO ACQUA - SINGLE WATER LINE

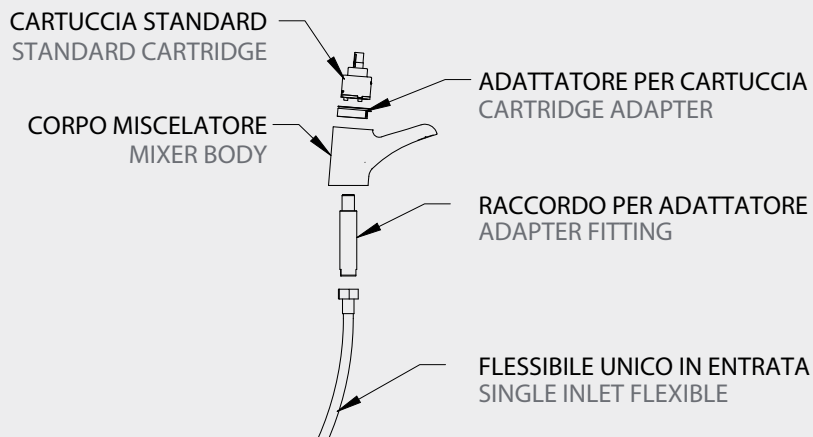

I rubinetti della linea mono acqua usano gli stessi principi dei miscelatori monocomando ma gestiscono il flusso di una sola acqua [generalmente l'acqua fredda] e sono alimentati da un singolo flessibile.

Girando la leva a destra e sinistra riceverete sempre acqua della stessa tipologia di temperatura mentre alzando e abbassando la leva ne regolerete la quantità di flusso come nei normali monocomando

The single water line taps use the same principles of the single lever mixers but they flow only one water [generally cold water] and they're supplied by a single flexible hose. Turning the handle on the right and on the left side you will always receive cold water while opening and closing the lever you regulate the flow as usual.



K 10 M

Miscelatore monocomando e monoacqua per lavabo, con scarico.
Single-lever single-water line basin mixer, with pop-up waste.

K 11 M

Miscelatore monocomando e monoacqua per lavabo, senza scarico.
Single-lever single-water line basin mixer, without pop-up waste.



K 11 G M

Miscelatore monocomando e monoacqua per lavabo o lavello, con bocca girevole.
Single-lever single-water line basin or sink mixer, with movable spout.

Single-lever single-water line basin or sink mixer, with movable spout.



K 10 L M

Miscelatore monocomando monoacqua per lavabo, con bocca lunga e scarico.
Single-lever single water basin mixer with long spout and pop-up waste.

K 11 L M

Miscelatore monocomando monoacqua per lavabo, con bocca lunga e senza scarico.
Single-lever single water basin mixer with long spout and without pop-up waste.



K 42 U M

Miscelatore monocomando monoacqua per lavello, con bocca alta a "U" girevole.
Single-lever single water one-hole sink mixer, with high "U" movable spout.

Single-lever single water one-hole sink mixer, with high "U" movable spout.



K 40 M

Miscelatore monocomando mono acqua per lavello, con bocca girevole.

Single-lever single-water one-hole sink mixer, with movable spout.

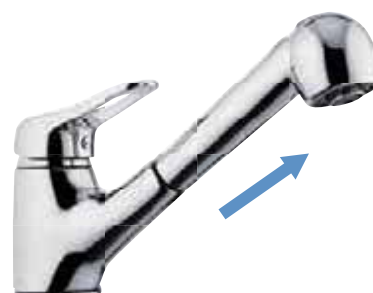

K 47 M

Miscelatore monocomando monoacqua per lavello, con doccia estraibile a getto variabile.

Single-lever single water one-hole sink mixer, with pull-out spray jet shower two functions.



K 42 M

Miscelatore monocomando mono acqua per lavello, con bocca alta girevole.

Single-lever single-water one-hole sink mixer, with high movable spout.



K 42 CM

Miscelatore monocomando mono acqua per lavello, con bocca alta girevole, tipo lusso, modello corto.

Single-lever single-water one-hole sink mixer, with high movable spout, shorter model, luxury type.



REMIX

La serie di miscelatori monocomando Remix si sviluppa intorno al concetto di piccolo miscelatore come alternativa più economica alle serie classiche, pur mantenendo inalterati i valori di qualità standard

La serie Remix presenta un design dalle linee squadrate, portando carattere e personalità anche su fasce di mercato più competitive.

The series of Remix single-lever mixers is built around the concept of small mixer as an economic alternative to the classic series, while maintaining the values of quality standards unchanged.

The Remix series presents a design with squared lines, bringing character and personality even on the most competitive market segments.





CARATTERISTICHE TECNICHE:

La serie è dotata di cartuccia a dischi ceramici Ø 35 mm, prodotta da S.T.S.R. - Studio Tecnico Sviluppo e Ricerche - www.stsr.it.

Finiture disponibili: cromo.

TECHNICAL CHARACTERISTICS:

The series is equipped with ceramic cartridge, Ø 35 mm, produced by S.T.S.R. - Research Development Technical Office - www.stsr.it.

Available finishes: chrome.



R 10

Miscelatore monocomando per lavabo, con scarico in ottone.
Single-lever basin mixer with brass pop-up waste.

R 10 P

Miscelatore monocomando per lavabo, con scarico in plastica.
Single-lever basin mixer with plastic pop-up waste.

R 11

Miscelatore monocomando per lavabo, senza scarico.
Single-lever basin mixer without pop-up waste.



R 11 G

Miscelatore monocomando per lavabo o lavello, con bocca girevole.
Single-lever one-hole basin or sink mixer, with movable spout.



R 20

Miscelatore monocomando per bidet, con scarico in ottone.
Single-lever bidet mixer with adjustable aerator and pop-up waste in brass.

R 20 P

Miscelatore monocomando per bidet, con scarico in plastica.
Single-lever bidet mixer with adjustable aerator and plastic pop-up waste.



R 21

Miscelatore monocomando per bidet, senza scarico.
Single-lever bidet mixer with adjustable aerator without pop-up waste.



R 02

Miscelatore monocomando per vasca, esterno, con doccia duplex.
Single-lever bath mixer with duplex shower.

R 05

Miscelatore monocomando per vasca, esterno, senza doccia.
Single-lever bath mixer without shower.



R 07

Miscelatore monocomando bordo vasca serie Remix con deviatore, bocca fusa e doccetta.

Single lever deck bath/shower mixer serie Remix with diverter, with casted spout and chrome plated hand shower.



R 30

Miscelatore monocomando da incasso per doccia.
Built-in shower single-lever mixer.



R 09

Miscelatore monocomando da incasso con deviatore per vasca/doccia.
Built-in bath/shower single-lever mixer with diverter.



R 31

Miscelatore monocomando esterno per doccia.
Wall mounted single-lever shower mixer.



R 39

Miscelatore monocomando esterno per doccia, con doccia duplex.
Wall mounted single-lever shower mixer, with duplex shower.



R 33

Miscelatore monocomando esterno per doccia, con leva frontale.
Wall mounted single-lever shower mixer, with frontal lever.



R 38

Miscelatore monocomando esterno per doccia, con leva frontale e doccia duplex.
Wall mounted single-lever shower mixer, with frontal lever and duplex shower.



91

Bocca incasso per miscelatore vasca-doccia.
Built-in spout for bath-shower mixer.



91 D

Bocca incasso vasca-doccia, con deviatore integrato.
Built-in spout for bath-shower, with diverter.



311 311 DA

Saliscendi con doccetta anticalcare, con getti in silicone.

Sliding rail set with anti-limestone handshower.



R 37

Gruppo doccia con colonna saliscendi e deviatore, completa di doccetta anticalcare 4 getti art. 321GR, flessibile e soffione art. 358GR 4 getti anticalcare.

Shower wall mounted mixer with deluxe sliding rail column and diverter, complete with handshower anti-limestone 4 jets art. 321GR, flexible hose and shower head art. 358GR, 4 jets, anti-limestone.



R 42

Miscelatore monocomando per lavello, con bocca alta girevole.
Single-lever one-hole sink mixer, with high movable spout.



R 42 C

Miscelatore monocomando per lavello, con bocca alta girevole, tipo lusso modello corto.
Single-lever one-hole sink mixer, with high movable spout, shorter model, luxury type.



R 43

Miscelatore monocomando per lavello a muro, con leva frontale e bocca alta girevole.

Single-lever wall mounted sink mixer, with frontal lever and high movable spout.



R 43 C

Miscelatore monocomando per lavello a muro, con leva frontale e bocca alta girevole, modello corto.

Single-lever wall mounted sink mixer, with frontal lever and high movable spout, shorter model.



R 42 U

Miscelatore monocomando per lavello, con bocca alta a "U" girevole.
Single-lever one-hole sink mixer, with high "U" movable spout.



R 40

Miscelatore monocomando per lavello, con bocca girevole.
Single-lever one-hole sink mixer, with movable spout.



R 42 R

Miscelatore monocomando per lavello, con bocca alta girevole, tipo lusso.
Single-lever one-hole sink mixer, with high movable spout, luxury type.



R 41

Miscelatore monocomando per lavello a muro, con bocca girevole.
Single-lever wall mounted sink mixer, with movable spout.



R 41 S

Miscelatore monocomando per lavello a muro, con bocca "S" girevole.
Single-lever wall mounted sink mixer, with "S" movable spout



R 46

Miscelatore lavabo/vasca con canna fusa lunga 30 cm e deviatore senza kit doccia.
Wall basin/bath single lever mixer with 30 cm long casted spout with diverter without duplex shower.

Wall basin/bath single lever mixer with 30 cm long casted spout with diverter without duplex shower.



R 49

Miscelatore lavabo/vasca con canna fusa lunga 30 cm e deviatore con kit doccia.
Wall basin/bath single lever mixer with 30 cm long casted spout with diverter with duplex shower.

Wall basin/bath single lever mixer with 30 cm long casted spout with diverter with duplex shower.





LINEA MONO ACQUA - SINGLE WATER LINE



R 10 M

Miscelatore monocomando e monoacqua per lavabo, con scarico.
Single-lever single-water line basin mixer, with pop-up waste.

R 11 M

Miscelatore monocomando e monoacqua per lavabo, senza scarico.
Single-lever single-water line basin mixer, without pop-up waste.



R 11 G M

Miscelatore monocomando e monoacqua per lavabo o lavello, con bocca girevole.
Single-lever single-water line basin or sink mixer, with movable spout.



R 42 M

Miscelatore monocomando mono acqua per lavello, con bocca alta girevole.
Single-lever single-water one-hole sink mixer, with high movable spout.



R 42 C M

Miscelatore monocomando mono acqua per lavello, con bocca alta girevole, tipo lusso, modello corto.
Single-lever single-water one-hole sink mixer, with high movable spout, shorter model, luxury type.



R 40 M

Miscelatore monocomando mono acqua per lavello, con bocca girevole.
Single-lever single-water one-hole sink mixer, with movable spout.



R 42 U M

Miscelatore monocomando monoacqua per lavello, con bocca alta a "U" girevole.
Single-lever single water one-hole sink mixer, with high "U" movable spout.



35

La serie di miscelatori monocomando 35 si sviluppa intorno al concetto di piccolo miscelatore come alternativa più economica alle serie classiche, pur mantenendo inalterati i valori di qualità standard. La serie 35 presenta un design minimizzato da linee arrotondate e nella sua semplicità risulta comunque un articolo ben studiato per fasce di mercato più competitive.

The series of 35 single-lever mixers is built around the concept of small mixer as an economic alternative to the classic series, while maintaining the values of quality standards unchanged.

The 35 series presents a design minimized by rounded lines and in its simplicity it's a well conceived article for most competitive market segments.





CARATTERISTICHE TECNICHE:

La serie è dotata di cartuccia a dischi ceramici Ø 35 mm, prodotta da S.T.S.R. - Studio Tecnico Sviluppo e Ricerche - www.stsr.it.

Finiture disponibili: cromo.

TECHNICAL CHARACTERISTICS:

The series is equipped with ceramic cartridge, Ø 35 mm, produced by S.T.S.R. - Research Development Technical Office - www.stsr.it.

Available finishes: chrome.



F 10 2

Miscelatore monocomando per lavabo, con scarico in plastica.
Single-lever basin mixer with plastic pop-up waste.

F 10 2 SO

Miscelatore monocomando per lavabo, con scarico in ottone.
Single-lever basin mixer with brass pop-up waste.

F 11 2

Miscelatore monocomando per lavabo, senza scarico.
Single-lever basin mixer without pop-up waste.



F 11 2 G

Miscelatore monocomando per lavabo o lavello, con bocca girevole.
Single-lever one-hole basin or sink mixer, with movable spout.



F 20 2

Miscelatore monocomando per bidet, con scarico in plastica.
Single-lever bidet mixer with adjustable aerator and pop-up waste in plastic.

F 20 2 SO

Miscelatore monocomando per bidet, con scarico in ottone.
Single-lever bidet mixer with adjustable aerator and brass pop-up waste.

F 21 2

Miscelatore monocomando per bidet, senza scarico.
Single-lever bidet mixer with adjustable aerator without pop-up waste.



F 23 2

Miscelatore monocomando per bidet, con doccia.
Single-lever bidet mixer with spray.



F 02 2

Miscelatore monocomando per vasca, esterno, con doccia duplex.
Single-lever bath mixer with duplex shower.

F 05 2

Miscelatore monocomando per vasca, esterno, senza doccia.
Single-lever bath mixer without shower.



F 07 2

Miscelatore monocomando bordo vasca serie 35 con deviatore, bocca fusa e doccetta.

Single lever deck bath/shower mixer serie 35 with diverter, with casted spout and chrome plated hand shower.



F 30 2

Miscelatore monocomando da incasso per doccia.
Built-in shower single-lever mixer.



F 09 2

Miscelatore monocomando da incasso con deviatore per vasca/ doccia.
Built-in bath/shower single-lever mixer with diverter.



91

Bocca incasso per miscelatore vasca-doccia.
Built-in spout for bath-shower mixer.



91 D

Bocca incasso vasca-doccia, con deviatore integrato.
Built-in spout for bath-shower, with diverter.





**F 38 2**

Miscelatore monocomando esterno per doccia, con leva frontale e doccia duplex.

Wall mounted single-lever shower mixer, with frontal lever and duplex shower.

F 33 2

Miscelatore monocomando esterno per doccia, con leva frontale.

Wall mounted single-lever shower mixer, with frontal lever.

**F 39 2**

Miscelatore monocomando esterno per doccia, con doccia duplex.

Wall mounted single-lever shower mixer, with duplex shower.

F 31 2

Miscelatore monocomando esterno per doccia.

Wall mounted single-lever shower mixer.

**F 36 2 EX**

Gruppo doccia con colonna 329 EX, e soffione doccia art. 351 A con 4 getti, anticalcare.

Shower wall mounted mixer with 329 EX pipe and shower head art. 351 A, with 4 jets, anti-limestone.



F 36 2

Gruppo doccia con colonna lusso e soffione doccia art. 358GR, 4 getti, anticalcare.

Shower wall mounted mixer with deluxe pipe and shower head art. 358GR, 4 jets, anti-limestone.



F 37 2

Gruppo doccia con colonna saliscendi e deviatore, completa di doccetta anticalcare 4 getti art. 321GR, flessibile e soffione art. 358GR 4 getti anticalcare.

Shower wall mounted mixer with deluxe sliding rail column and diverter, complete with handshower anti-limestone 4 jets art. 321GR, flexible hose and shower head art. 358GR, 4 jets, anti-limestone.



F 40 2
Miscelatore monocomando per lavello, con bocca girevole.
Single-lever one-hole sink mixer, with movable spout.



F 42 2 U
Miscelatore monocomando per lavello, con bocca alta a "U" girevole.
Single-lever one-hole sink mixer, with high "U" movable spout.



F 42 2
Miscelatore monocomando per lavello, con bocca alta girevole.
Single-lever one-hole sink mixer, with high movable spout.



F 42 2 C
Miscelatore monocomando per lavello, con bocca alta girevole,
modello corto.
Single-lever one-hole sink mixer, with high movable spout, shorter model.



F 42 2 R
Miscelatore monocomando per lavello, con bocca alta girevole, tipo lusso.
Single-lever one-hole sink mixer, with high movable spout, luxury type.



F 43 2

Miscelatore monocomando per lavello a muro, con leva frontale e bocca alta girevole.

Single-lever wall mounted sink mixer, with frontal lever and high movable spout.



F 43 2 C

Miscelatore monocomando per lavello a muro, con leva frontale e bocca alta girevole, modello corto.

Single-lever wall mounted sink mixer, with frontal lever and high movable spout, shorter model.



F 41 2

Miscelatore monocomando per lavello a muro, con bocca girevole.

Single-lever wall mounted sink mixer, with movable spout.



F 41 2 S

Miscelatore monocomando per lavello a muro, con bocca a "S" girevole.

Single-lever wall mounted sink mixer, with "S" movable spout.



F 46 2

Miscelatore lavabo/vasca con canna fusa lunga 30 cm e deviatore senza kit doccia.

Wall basin/bath single lever mixer with 30 cm long casted spout with diverter without duplex shower.



F 49 2

Miscelatore lavabo/vasca con canna fusa lunga 30 cm e deviatore con kit doccia.

Wall basin/bath single lever mixer with 30 cm long casted spout with diverter with duplex shower.

LINEA MONO ACQUA - SINGLE WATER LINE

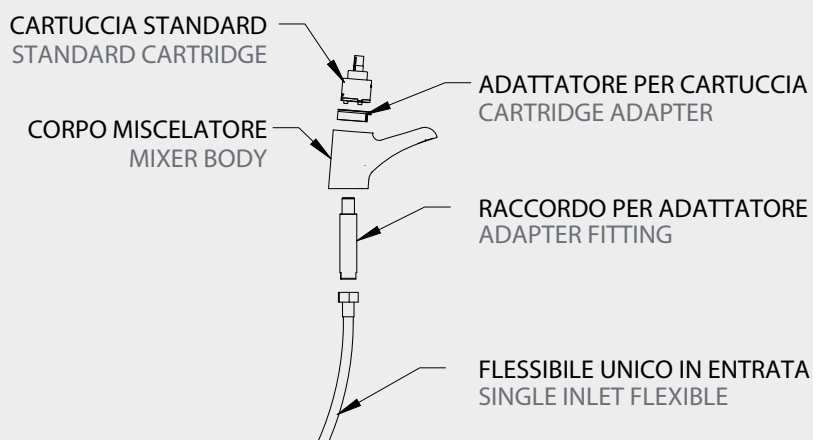

I rubinetti della linea mono acqua usano gli stessi principi dei miscelatori monocomando ma gestiscono il flusso di una sola acqua (generalmente l'acqua fredda) e sono alimentati da un singolo flessibile.

Girando la leva a destra e sinistra riceverete sempre acqua della stessa tipologia di temperatura mentre alzando e abbassando la leva ne regolerete la quantità di flusso come nei normali monocomando

The single water line taps use the same principles of the single lever mixers but they flow only one water (generally cold water) and they're supplied by a single flexible hose. Turning the handle on the right and on the left side you will always receive cold water while opening and closing the lever you regulate the flow as usual.

**F 10 2 M**

Miscelatore monocomando e monoacqua per lavabo, con scarico.
Single-lever single-water line basin mixer, with pop-up waste.

F 11 2 M

Miscelatore monocomando e monoacqua per lavabo, senza scarico.
Single-lever single-water line basin mixer, without pop-up waste.

**F 11 2 G M**

Miscelatore monocomando e monoacqua per lavabo o lavello, con bocca girevole.

Single-lever single-water line basin or sink mixer, with movable spout.

**F 40 2 M**

Miscelatore monocomando mono acqua per lavello, con bocca girevole.

Single-lever single-water one-hole sink mixer, with movable spout.

**F 42 2 M**

Miscelatore monocomando mono acqua per lavello, con bocca alta girevole.

Single-lever single-water one-hole sink mixer, with high movable spout.



F 42 2 C M

Miscelatore monocomando mono acqua per lavello, con bocca alta girevole modello corto.

Single-lever single-water one-hole sink mixer, with high movable spout, shorter model, luxury type.



F 42 2 U M

Miscelatore monocomando per lavello, con bocca alta a "U" girevole.

Single-lever single water one-hole sink mixer, with high "U" movable spout.



100

Cento si caratterizza da un interasse estremamente ridotto a 100 mm per attrezzare in modo adeguato bagni o spazi molto piccoli.

La serie, pur rispecchiando tutti gli standard qualitativi si posiziona su di una fascia molto competitiva, dato il ridotto volume degli articoli stessi.

Cento - One Hundred - is characterised by an extremely reduced interaxis of 100 mm to equip in an adequate way small bathrooms or spaces.

The line, thus respecting all quality standards, is positioned of a very competitive level, because of the reduced volume of these items.



100



CARATTERISTICHE TECNICHE:

La serie è dotata di cartuccia a dischi ceramici Ø 35 mm, prodotta da S.T.S.R. - Studio Tecnico Sviluppo e Ricerche - www.stsr.it. Interasse 100 mm.

Finiture disponibili: cromo.

TECHNICAL CHARACTERISTICS:

The series is equipped with ceramic cartridge, Ø 35 mm, produced by S.T.S.R. - Research Development Technical Office - www.stsr.it. 100 mm interaxis.

Available finishes: chrome.



C 02 2

Miscelatore monocomando per vasca interasse 100, esterno, con doccia duplex.

Single-lever bath mixer interaxis 100 with duplex shower.



C 05 2

Miscelatore monocomando per vasca, interasse 100, esterno, senza kit doccia.

Single-lever bath mixer interaxis 100 without shower set.

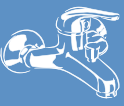

C 33 2

Miscelatore monocomando, interasse 100, esterno per doccia, con leva frontale, senza set doccia.

Wall mounted single-lever shower mixer, interaxis 100, with front lever, without shower set.



C 38 2

Miscelatore monocomando esterno per doccia, interasse 100, con leva frontale e doccia duplex.

Wall mounted single-lever shower mixer, interaxis 100, with front lever and duplex shower.



C 31 2

Miscelatore monocomando esterno per doccia, interasse 100, senza set doccia.

Wall mounted single-lever shower mixer, interaxis 100, without shower set.



314 311 DA

Saliscendi con doccetta anticalcare, con getti in silicone.

Sliding rail set with anti-limestone handshower.



C 39 2

Miscelatore monocomando per doccia, interasse 100, con doccia duplex.

Wall mounted single-lever shower mixer, interaxis 100, with duplex shower.





C 43 2

Miscelatore monocomando esterno per lavello con leva frontale e bocca alta, interasse 100.

Single lever mixer for sink, external mounted, with frontal lever and high spout, interaxis 100.



C 43 2 C

Miscelatore monocomando esterno per lavello con leva frontale e canna corta fusa, modello corto.

Single lever mixer for sink, external mounted, with frontal lever and shorter model.



C 41 2

Miscelatore monocomando per lavello a muro, con bocca girevole, interasse 100.

Single-lever sink mixer, movable spout, interaxis 100.



C 41 2 S

Miscelatore monocomando per lavello a muro, con bocca a "S" girevole, interasse 100.

Single-lever sink mixer, with "S" movable spout, interaxis 100.



C 49 2

Miscelatore lavabo/vasca con canna fusa lunga 30 cm e deviatore con kit doccia, interasse 100.

Wall basin/bath single lever mixer with 30 cm long casted spout with diverter and duplex shower, interaxis 100.



C 46 2

Miscelatore lavabo/vasca con canna fusa lunga 30 cm e deviatore senza kit doccia, interasse 100.

Wall basin/bath single lever mixer with 30 cm long casted spout with diverter without duplex shower, interaxis 100.





C 31 2 REL

Miscelatore monocomando esterno doccia, interasse 100, con kit composto da doccetta shut-off in ottone cromato art. 332OL, flessibile conico in ottone cromato 120 cm e supporto "lux" in ottone cromato.

Wall mounted single-lever shower mixer interaxis 100, with kit composed by shut-off handshower in c.p. brass art. 332OL, conical flexible in c.p. brass cm 120 and "lux" support in c.p. brass.



C 33 2 REL

Miscelatore monocomando esterno doccia, interasse 100, con leva frontale e kit composto da doccetta shut-off in ottone cromato art. 332OL, flessibile conico in ottone cromato 120 cm e supporto "lux" in ottone cromato.

Wall mounted single-lever shower mixer interaxis 100, with frontal lever, with kit composed by shut-off handshower in c.p. brass art. 332OL, conical flexible in c.p. brass cm 120 and "lux" support in c.p. brass.



C 31 2 RELA

Miscelatore monocomando esterno doccia, interasse 100, con kit composto da doccetta shut-off in ottone cromato art. 332OLA, flessibile conico in ottone cromato 120 cm e supporto "lux" in ottone cromato.

Wall mounted single-lever shower mixer interaxis 100, with kit composed by shut-off handshower in c.p. brass art. 332OLA, conical flexible in c.p. brass cm 120 and "lux" support in c.p. brass.



C 33 2 RELA

Miscelatore monocomando esterno doccia, interasse 100, con leva frontale e kit composto da doccetta shut-off in ottone cromato art. 332OLA, flessibile conico in ottone cromato 120 cm e supporto "lux" in ottone cromato.

Wall mounted single-lever shower mixer interaxis 100, with frontal lever, with kit composed by shut-off handshower in c.p. brass art. 332OLA, conical flexible in c.p. brass cm 120 and "lux" support in c.p. brass.



C 31 2 DP

Miscelatore monocomando esterno doccia, interasse 100, con kit composto da doccetta shut-off in abs cromato art. 332DPCR, flessibile conico in ottone cromato 120 cm e gancio cromato art. 332GA.

Wall mounted single-lever shower mixer, interaxis 100, with kit composed by shut-off handshower in c.p. abs art. 332DPCR, conical flexible in c.p. brass cm 120 and c.p. hook art. 332GA.



C 33 2 DP

Miscelatore monocomando esterno doccia con leva frontale, interasse 100, con kit composto da doccetta shut-off in abs cromato art. 332DPCR, flessibile conico in ottone cromato 120 cm e gancio cromato art. 332GA.

Wall mounted single-lever shower mixer, interaxis 100, with frontal lever and kit composed by shut-off handshower in c.p. abs art. 332DPCR, conical flexible in c.p. brass cm 120 and c.p. hook art. 332GA.





LIBERTY

L'eleganza della tradizione trova la massima fonte di ispirazione nella serie Liberty, una serie senza tempo in quanto specchio di uno stile classico dal fascino intramontabile.

La serie Liberty è molto completa e si compone sia di elementi monoforo che di elementi a tre o più fori, così come si usava una volta e così come ancora si usa, quando si vuol rendere ancor più deciso il carattere tradizionale e romantico di questo miscelatore tradizionale.

The elegance of tradition finds its greatest source of inspiration in the Liberty series, a timeless series as a mirror of a timeless charm classic style.

The Liberty series is very complete and consists both of one-hole elements and three-or-more-hole elements, the same as they used once and is still used when you want to make the traditional and romantic character of this traditional mixer even more defined.



CARATTERISTICHE TECNICHE:

La serie è normalmente dotata di vitoni tradizionali, a richiesta è disponibile anche con vitoni ceramici S.T.S.R. - www.stsr.it.



Disponibile anche con vitone ceramico; aggiungere CE alla fine del codice.

TECHNICAL CHARACTERISTICS:

The series is standard equipped with traditional head valves; it is also available with ceramic cartridge S.T.S.R. on demand - www.stsr.it.



Available also with ceramic headvalve; add CE at the end of the article number.



11 LI

Batteria lavabo con scarico automatico 1"1/4.
Basin mixer set with pop-up waste, 1"1/4.



11 C LI

Batteria lavabo con bocca a "C" e scarico automatico 1"1/4.
Basin mixer set with "C" spout and pop-up waste, 1"1/4.



13 LI

Monoforo lavabo con scarico automatico 1"1/4.
One-hole basin mixer with pop-up waste, 1"1/4.



13 LI B

Monoforo lavabo con scarico click-clack.
One-hole washbasin mixer with click-clack pop-up waste.



13 G LI

Miscelatore tradizionale monoforo per lavabo serie Liberty, con canna alta e scarico.

One-hole traditional sink mixer serie Liberty, with high spout and pop-up waste.



13 C LI

Miscelatore tradizionale monoforo per lavabo serie Liberty, con canna fusa e scarico.

One-hole traditional sink mixer serie Liberty, with casted spout and pop-up waste.



13 A LI

Miscelatore tradizionale monoforo per lavabo serie Liberty, con canna antica e scarico.

One-hole traditional sink mixer serie Liberty, with "Antique" spout and pop-up waste.



13 U LI

Miscelatore tradizionale monoforo per lavabo serie Liberty, con canna tubo e scarico.

One-hole traditional sink mixer serie Liberty, with tube spout and pop-up waste.



14 LI

Gruppo lavabo tipo a ponte, canna Ø18 cm.

Wash basin mixer bridge type, spout Ø18 cm.



21 LI

Batteria bidet con scarico automatico 1"1/4.

Bidet mixer set with pop-up waste, 1"1/4.



22 LI

Batteria bidet con doccia e scarico 1"1/4.

Bidet mixer with spray and pop-up waste, 1"1/4.



23 LI

Monoforo bidet con scarico automatico 1"1/4.

One-hole bidet mixer with pop-up waste, 1"1/4.



02 LI

Gruppo vasca con doccia duplex.
Bathtub mixer with duplex shower.

05 LI

Gruppo vasca senza doccia duplex.
Bathtub mixer without duplex shower.



02 LI UK

Gruppo vasca esterno su colonnette alte Liberty, con doccia.
Traditional bathtub mixer, on Liberty high columns, with shower.



06 LI

Miscelatore tradizionale bordo vasca serie Liberty con deviatore, bocca pesante fusa e doccetta in ottone.
Traditional deck bath/shower mixer serie Liberty, with diverter, heavy casted spout and pull-out handshower in brass.

Traditional deck bath/shower mixer serie Liberty, with diverter, heavy casted spout and pull-out handshower in brass.



04 LI

Gruppo vasca esterno con doccia duplex e canna lunga girevole.
Bathtub mixer with duplex shower and long movable spout.



LIBERTY



01 LI

Gruppo vasca esterno su colonne da pavimento Liberty, con doccia.
Traditional bathtub mixer, on Liberty floor columns, with shower.



88 01 LI

Colonne da pavimento Liberty.
Liberty floor columns.



03 LI S 01

Batteria vasca incasso con deviatore, bocca fusa e set doccia composto da supporto-presa acqua e doccetta in ottone cromato liberty.

Built-in three bathtub mixer with diverter, casted spout and shower set composed by water punch-shower support and handshower in c.p. brass, Liberty model.



03 LI S 02

Batteria vasca incasso con deviatore e set doccia composto da : supporto- presa acqua e doccetta in ottone cromato liberty e braccio doccia con soffione a campanella.

Built-in three bathtub mixer with diverter and shower set composed by water punch-shower support and handshower in c.p. brass, Liberty model, and shower arm with shower-head bell shaped.



08 LI

Gruppo vasca con colonna doccia lusso e soffione doccia in ottone cromato.

Bathtub mixer with deluxe pipe and shower head bell.



09 LI

Miscelatore vasca-doccia serie Liberty con colonna saliscendi con deviatore e doccetta Liberty con flessibile e soffione doccia a campanella. Tutti gli elementi sono esclusivamente in ottone cromato.

Bath-shower traditional mixer serie Liberty, with sliding rail column with diverter and Liberty handshower, with shower hose and shower head Bell. All the elements included in this article are completely in chrome plated brass.



07 LI

Gruppo vasca con deviatore e attacco 3/4M.

Bathtub mixer with diverter and 3/4M connection.



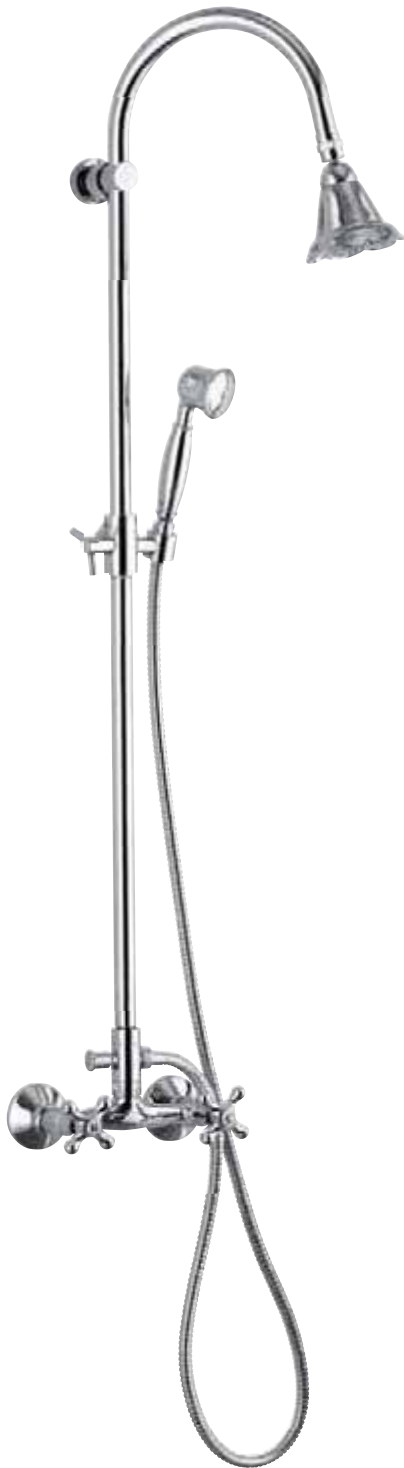

37 LI

Gruppo doccia con colonna saliscendi e deviatore, completa di doccetta con flessibile e soffione a campanella, tutto in ottone cromato.

Shower wall mounted mixer with deluxe sliding rail column and diverter, complete with handshower, flexible hose and shower head bell shaped, all in c.p. brass.

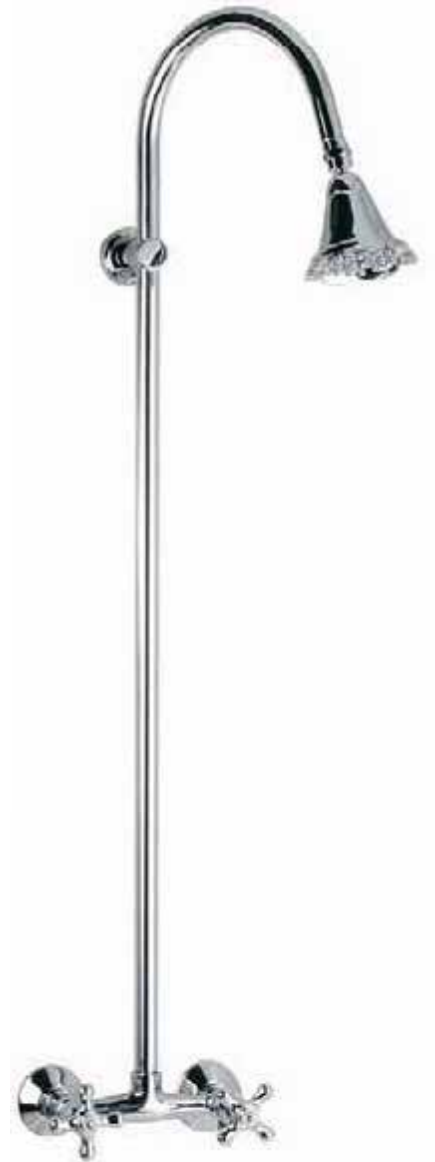

36 LI

Gruppo doccia con colonna lusso e soffione doccia a campanella, tutto in ottone cromato.

Shower wall mounted mixer with deluxe pipe and brass shower rose bell shaped.



317L 323CR

Saliscendi Liberty lusso, completamente in ottone cromato, con asta tonda e doccetta in ottone cromato modello Liberty.

Luxury Liberty sliding rail set, completely in C.P. brass, with round rod and Liberty C.P. brass handshower.



35 LI

Gruppo doccia a muro con attacco 3/4" M.

Wall mounted shower mixer with 3/4" M connection.



39 LI

Gruppo doccia a muro con doccia duplex.

Wall mounted shower mixer with duplex shower.



38 LI

Gruppo doccia a muro, senza kit doccia.

Shower wall mounted mixer without shower kit.



43 LI

Gruppo lavello monoforo con canna girevole.
One-hole sink mixer with swivel spout.



43 LI A

Monoforo lavello con canna antica.
One-hole sink mixer with antique spout.



43 LI J

Gruppo lavello monoforo con canna Jota.
One-hole sink mixer with swivel J spout.



41 LI J

Gruppo lavello a muro con canna superiore Jota.
Sink mixer wall mounted, with swivel high J spout.



41 LI

Gruppo lavello a muro con canna inferiore.
Sink mixer wall mounted tap, with swivel spout.



41 S LI

Gruppo lavello a muro con canna superiore.
Sink mixer wall mounted, with swivel high spout.



15 LI

Rubinetto collo cigno 1/2, 3/4.
Wash basin pillar tap, 1/2, 3/4.



31 LI

Rubinetto incasso dritto, 1/2, 3/4.
Built-in straight stop cock, 1/2, 3/4.



51 LI

Rubinetto prolungato, 1/2".
Wall mounted long tap, 1/2".



52 LI

Rubinetto con portagomma, 1/2".
Wall mounted hose-holder tap, 1/2".



53 LI

Rubinetto a snodo pesante, 1/2" canna Ø 18, con rompigitto.
Sink tap, with swivel spout Ø18, 1/2" and aerator.



53 S LI

Rubinetto a snodo pesante, 1/2" con canna alta a "S" Ø 18 girevole, con rompigitto.
Sink tap 1/2" with high "S" swivel spout Ø 18, and aerator.



53 J LI

Rubinetto a snodo pesante, 1/2" canna alta "J", Ø 18, con canna girevole e rompigitto.
Sink tap 1/2", with high "J" swivel spout Ø 18 and aerator.



54 LI

Rubinetto monoforo per lavello con canna alta a "J" e rompigitto.
One-hole sink tap, with high "J" swivel spout and aerator.



252 LI

Rubinetto a snodo con attacco lavatrice e attacco da 1/2" con canna ad S girevole.

Washing machine bibcock, with swivel spout 1/2".



55 LI

Rubinetto a squadra per lavatrice, 1/2" x 3/4".

Angle tap for washing machine 1/2" x 3/4".



57 LI

Rubinetto curvo con maniglia MINI Y, 1/2".

Elbow tap with MINI Y handle, 1/2".



58 LI

Rubinetto curvo con portagomma maniglia MINI Y, 1/2".

Elbow tap, with hose connection, with MINI Y handle, 1/2".



251 LI

Rubinetto curvo con uscita da 1/2" e uscita da bocca di erogazione, attacco 1/2" M.

Angle tap with 1/2" output and spout output, 1/2" M connection.



1000-2000

La serie 1000/2000 è da sempre presente nel panorama vendite in quanto rappresenta la base storica del rubinetto tradizionale, avendo inoltre una varietà di maniglie tale da potersi vestire secondo la necessità, sia di nuovo impianto che di ristrutturazione o sostituzione.

La serie si posiziona su di una fascia di mercato competitiva pur mantenendo la qualità che caratterizza tutti i prodotti

The 1000/2000 series has always been present on the sales-range as it represents the historical basis of the traditional tap, also having such a variety of handles to be able to “dress up” according to the needs, both new planting as well as restructuring or replacement ones.

The series is positioned on a competitive market segment while maintaining the quality characterizing all products.



10000
20000



CARATTERISTICHE TECNICHE:

La serie è normalmente dotata di vitoni tradizionali, a richiesta è disponibile anche con vitoni ceramici S.T.S.R. - www.stsr.it.

TECHNICAL CHARACTERISTICS:

The series is standard equipped with traditional head valves; it is also available with ceramic cartridge S.T.S.R. on demand - www.stsr.it.



11 EX

Batteria lavabo con scarico automatico, 1"1/4.
Wash basin mixer with pop-up waste 1"1/4.



12 EX

Batteria lavabo senza scarico.
Wash basin mixer without pop-up waste.



13 EX

Monoforo lavabo con scarico automatico, 1"1/4.
One-hole wash basin mixer with pop-up waste 1"1/4.



15 EX

Rubinetto collo cigno 1/2.
Wash basin pillar tap, 1/2.



14 EX

Gruppo lavabo tipo a ponte, canna Ø18.
Wash basin mixer bridge type, spout Ø18.



14 C EX

Gruppo lavabo tipo a ponte, canna alta a "C".
Wash basin mixer bridge type, high "C" spout.



17 EX

Gruppo lavabo con interasse 160 mm e canna a jota Ø18.
Wash basin mixer deck-mounted interaxis 160 mm. with jota spout. Ø18.



21 EX

Combinazione bidet con scarico automatico, 1"1/4.
Bidet mixer with pop-up waste 1"1/4.



22 EX

Batteria bidet con doccia e scarico, 1"1/4.
Bidet mixer with spray and pop-up waste 1"1/4.



23 EX

Monoforo bidet con scarico automatico, 1"1/4.
One-hole bidet mixer with pop-up waste 1"1/4.



25



31



32

25 EX

Rubinetto bidet 1/2.
Bidet tap 1/2.

31 EX

Rubinetto incasso diritto 1/2.
Built-in stop cock, 1/2.

32 EX

Rubinetto incasso a sfera removibile con maniglia, 1/2, 3/4.
Built-in stop cock with removable ball valve, with handle, 1/2, 3/4.



33 EX

Rubinetto incasso con cappuccio a 2 pezzi, 1/2, 3/4.
Built-in stop cock with chromed cap in 2 pieces, 1/2, 3/4.



34 EX

Rubinetto incasso a sfera con cappuccio a 2 pezzi, 1/2, 3/4.
Built-in ball valve with chromed cap in 2 pieces, 1/2, 3/4.



35 EX

Rubinetto incasso a sfera con maniglia a leva, 1/2, 3/4.
Built-in ball valve with lever handle, 1/2, 3/4.



01 EX

Gruppo vasca esterno con doccia.
Bathtub mixer with normal shower.



02 EX

Gruppo vasca esterno con doccia duplex.
Bathtub mixer with duplex shower.



04 EX

Gruppo vasca esterno con doccia duplex e canna lunga girevole.
Bathtub mixer with duplex shower and long movable spout.



05 EX

Gruppo vasca esterno senza kit doccia.
Bathtub mixer without shower kit.



07 EX

Gruppo vasca con deviatore e attacco 3/4 M.
Bathtub mixer with diverter and 3/4 M connection.

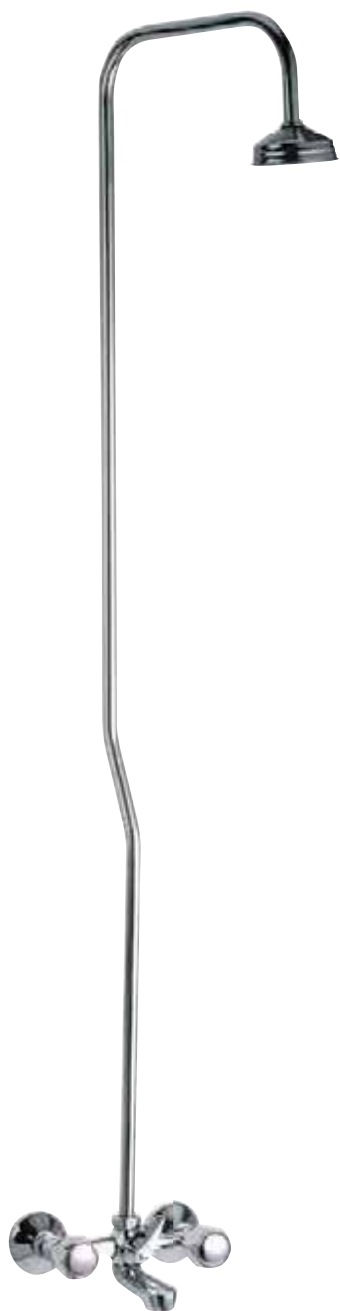

08 EX

Gruppo vasca con colonna doccia 1/2x3/4 e soffione doccia standard.

Bathtub mixer with stand pipe 1/2x3/4 and standard shower rose.



329 EX 351 EX

Colonna doccia 1/2x3/4 e soffione doccia standard.

Stand pipe 1/2x3/4 and standard shower rose.



38 EX

Gruppo esterno per doccia.

Wall mounted shower mixer.



39 EX

Gruppo esterno per doccia, con doccia duplex.

Wall mounted shower mixer, with duplex shower.



55 EX 329 351 EX

Colonna doccia 1/2x3/4 con soffione doccia standard e rubinetto a squadra.

Stand pipe 1/2x3/4 with standard shower head and angle tap.



38 EX 329 351 EX

Miscelatore esterno doccia con attacco alto e colonna doccia 1/2x3/4 con soffione doccia standard.

Wall mounted shower mixer with higher connection with stand pipe 1/2x3/4 with standard shower head.



41 EX

Gruppo lavello con canna inferiore girevole a "S".
Sink mixer wall mounted, with low "S" swivel spout.



41 S EX

Gruppo lavello con canna superiore.
Sink mixer wall mounted, with high swivel spout.



41 J EX

Gruppo lavello con canna alta girevole.
Sink mixer wall mounted, with high swivel spout.



42 EX

Gruppo lavello con attacco lavatrice, con canna inferiore.
Sink mixer with washing machine connection with low swivel spout.



43 EX

Monoforo lavello con canna girevole.
One-hole sink mixer with swivel spout.



43 C EX

Monoforo lavello con canna girevole, modello tipo corto.
One-hole sink mixer with swivel spout, shorter model.



45 EX

Monoforo lavello con canna girevole.
One-hole sink mixer with swivel spout.



46 EX

Monoforo lavello con deviatore lavastoviglie.
One-hole sink mixer with dish washer diverter and spout.



47 EX

Monoforo lavello con doccia estraibile.
One-hole sink mixer with pull-out spray jet shower.



48 EX

Gruppo miscelatore per boiler con canna girevole e due cannuce in rame cromato, maniglia CAPRICE, 1/2.

Mixer for water heater with swiveling spout and two c.p. copper pipes, caprice handle, 1/2.



51 EX

Rubinetto prolungato, 1/2.
Wall mounted long tap, 1/2.



52 EX

Rubinetto con portagomma, 1/2.
Wall mounted hose-holder tap, 1/2.



53 EX

Rubinetto a snodo pesante, 1/2 canna Ø 18, con rompigitto.
Sink tap, with swivel spout Ø 18, 1/2 and aerator.



53 S EX

Rubinetto a snodo pesante, 1/2 con canna alta a "S" Ø18 girevole, con rompigitto.
Sink tap 1/2, with high "S" swivel spout Ø18, and aerator.



53 J EX

Rubinetto a snodo pesante, 1/2 con canna alta a "J" diam. 18 girevole, con rompigitto.
Sink tap 1/2, with high "J" swivel spout Ø18, and aerator.



55 EX

Rubinetto a squadra per lavatrice, 1/2x3/4.
Angle tap for washing machine 1/2x3/4.



54 EX

Rubinetto monoforo per lavello con canna alta a "J" e rompigetto.
One-hole sink tap, with high "J" swivel spout and aerator.



57 EX

Rubinetto curvo con maniglia MINI Y,
Elbow tap with MINI Y handle, 1/2



58 EX

Rubinetto curvo con portagomma maniglia MINI Y, 1/2.
Elbow tap, with hose connection, with MINI Y handle, 1/2".



250 EX

Rubinetto a due maniglie per attacco lavatrice, 1/2" x 3/4".
C.P. brass washing machine bibcock, heavy model, 1/2" x 3/4".



250 1/2x3/4 EX

Rubinetto a due maniglie per attacco lavatrice, 1/2" x 3/4" x 3/4".
C.P. brass washing machine bibcock, heavy model, 1/2" x 3/4" x 3/4".



252 EX

Rubinetto a snodo con attacco lavatrice e bocca girevole, 1/2".
C.P. brass washing machine bibcock, with swivel spout, 1/2".



251 EX

Rubinetto curvo con uscita da 1/2" e uscita da bocca di erogazione,
attacco 1/2" M.
Angle tap with 1/2" output and spout output, 1/2" M connection.



CUCINA KITCHEN





Il programma cucina **Rubinetterie** comprende una vasta gamma di articoli creati con la cura e la precisione che per tradizione caratterizzano i nostri prodotti **Made in Italy**.

La molteplici linee proposte dal nostro catalogo generale abbracciano le esigenze dello spazio cucina a più livelli. Arredano ambienti di design moderno, ambienti più tradizionali o country, giovani e allegri o molto tecnici, arrivando fino al mondo del professionale tramite la linea "**Gourmet**", completa ed indubbiamente in voga anche su isole di cucine private.

Tutti i miscelatori , siano monocomando, tradizionali, più

prestigiosi o più semplici, godono tutti della stessa mentalità sulla qualità e vale a dire:

- **Ottone e materiali a norma:** l'articolo è igienico e adatto all'uso alimentare
- **Ottimali livelli di cromatura e nichelatura:** l'articolo si presenta bene ora e nel tempo
- **Una componentistica di prima qualità:** per elevare lo standard qualitativo
- **Cartuccia o vitoni ceramici STSR** (Studio Tecnico Sviluppo e Ricerca, Lacchiarella -MI)
- **Flessibili Flexitaly:** (Flexitaly Srl, Cassano d'Adda -MI)
- Testati e controllati scrupolosamente uno a uno con rigorosi controlli multilivello e multireparto.

La scelta di un nostro miscelatore è sinonimo di sicurezza, la nostra azienda si impegna infatti quotidianamente a garantire ai propri clienti il meglio che la tecnologia costruttiva possa offrire.



The kitchen program of **Rubinetterie** includes a wide range of products created with care and precision that traditionally characterize our products **Made in Italy**.

The different lines proposed in our catalogue meet the needs of the kitchen space at multiple levels. They decorate the modern design rooms, more traditional or country, young and cheerful or very technical, reaching up the professional world through the line "**Gourmet**", complete and certainly in vogue also on private kitchen-islands.

mixers, both single-lever and traditional, more

prestigious and simpler ones, all carry on the same quality concept, that is:

- **Brass and materials in accordance with rules:** the item is hygienic and suitable for alimentary use.
- **Optimum levels of chrome and nickel plating:** the item looks good now and in time
- **Top-quality components:** to raise the quality standard
- **Cartridge or ceramic head valves STSR** (Technical, Development and Research Dept., Lacchiarella-MI- Italy)
- **Flexibles Flexitaly:** (Flexitaly Srl, Cassano d'Adda-MI- Italy)
- Thoroughly tested and inspected one by one with strict multilevel and multi-department controls.

The choice of a one of our mixer is synonymous of safety, actually our company's daily commitment is to provide customers with the best that construction technology can offer.



Q 73

Miscelatore monocomando con base quadrata.
Single-lever mixer with squared body.

Miscelatore monocomando laterale per lavello, alto, con bocca a U girevole e doccetta dual jet a doppio getto.

Materiale: miscelatore in ottone cromato.

Canna: forma a 180°, girevole, Ø mm 24.

Interasse miscelatore: cm 21,5.



N 73

Miscelatore monocomando con base tonda.
Single-lever mixer with round body.

Single-lever mixer for sink, with side lever, high U movable spout and dual jet shower.

Material: mixer and spout in c.p. brass.

Spout: shape 180°, swivelling, Ø mm 24.

Mixer interaxis: cm 21,5.



Q 82

Miscelatore monocomando con base quadrata.
Single-lever mixer with squared body.



N 82

Miscelatore monocomando con base tonda.
Single-lever mixer with round body.

Miscelatore monocomando laterale per lavello, alto, con bocca girevole e doccetta ad angolo retto estraibile a due funzioni.

Materiale: miscelatore e bocca in ottone cromato, doccetta in abs cromato.

Canna: forma a 90°, girevole, Ø mm 35.

Interasse miscelatore: cm 20.

Single-lever mixer for sink, with side lever, high movable spout with 90° corner shaped pull-out hand shower, two functions.

Material: mixer and spout in c.p. brass, handshower in c.p. abs.

Spout: shape 90°, swivelling, Ø mm 35.

Mixer interaxis: cm 20.



Q 82 C

Miscelatore monocomando con base quadrata.
Single-lever mixer with squared body.



N 82 C

Miscelatore monocomando con base tonda.
Single-lever mixer with round body.

Miscelatore monocomando laterale per lavello, alto, con bocca girevole e doccetta curva estraibile a due funzioni.

Materiale: miscelatore e bocca in ottone cromato, doccetta in abs cromato.

Canna: forma a 90°, girevole, Ø mm 35.

Interasse miscelatore: cm 20.

Single-lever mixer for sink, with side lever, high movable spout with pull-out hand shower, two functions.

Material: mixer and spout in c.p. brass, hand shower in c.p. abs.

Spout: shape 90°, swivelling, Ø mm 35.

Mixer interaxis: cm 20.





Q 83 A

Miscelatore monocomando con base quadrata.
Single-lever mixer with squared body.



N 83 A

Miscelatore monocomando con base tonda.
Single-lever mixer with round body.

Miscelatore monocomando laterale per lavello, alto, con bocca girevole e doccetta estraibile a due funzioni.

Materiale: miscelatore e bocca in ottone cromato, doccetta in abs cromato.

Canna: forma a 45°, girevole, Ø mm 30.

Interasse miscelatore: cm 20.

Single-lever mixer for sink, with side lever, high movable spout with pull-out hand shower, two functions.

Material: mixer and spout in c.p. brass, hand shower in c.p. abs.

Spout: shape 45°, swivelling, Ø mm 30.

Mixer interaxis: cm 20.



Q 83 B

Miscelatore monocomando con base quadrata.
Single-lever mixer with squared body.



N 83 B

Miscelatore monocomando con base tonda.
Single-lever mixer with round body.

Miscelatore monocomando laterale per lavello, alto, con bocca girevole e doccetta in ottone cromato estraibile a due funzioni.

Materiale miscelatore: ottone cromato.

Canna: forma a 45°, girevole, Ø mm 30, in ottone cromato.

Interasse miscelatore: cm 20.

Single-lever mixer for sink, with side lever, high movable spout with pull-out hand shower, two functions.

Material: mixer, spout and hand shower in c.p. brass.

Spout: shape 45°, swivelling, Ø mm 30.

Mixer interaxis: cm 20.

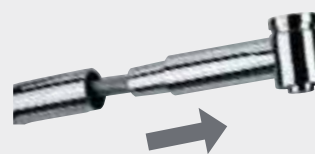



Q 83 C

Miscelatore monocomando con base quadrata.
Single-lever mixer with squared body.



N 83 C

Miscelatore monocomando con base tonda.
Single-lever mixer with round body.

Miscelatore monocomando laterale per lavello, alto, con bocca girevole e doccetta curva estraibile a due funzioni.

Materiale: miscelatore in ottone cromato, doccetta in abs cromato.

Canna: forma a 45°, girevole, Ø mm 35, in ottone cromato.

Interasse miscelatore: cm 20.

Single-lever mixer for sink, with side lever, high movable spout with pull-out hand shower, two functions.

Material: mixer and spout in c.p. brass, handshower in c.p. abs.

Spout: shape 45°, swivelling, Ø mm 35.

Mixer interaxis: cm 20.



Q 85

Miscelatore monocomando con base quadrata.
Single-lever mixer with squared body.



N 85

Miscelatore monocomando con base tonda.
Single-lever mixer with round body.

Miscelatore monocomando laterale per lavello, alto, con bocca a C girevole e doccetta estraibile a due funzioni.

Materiale: miscelatore in ottone cromato, doccetta in abs cromato.

Canna: forma a 180°, girevole, Ø mm 35

Interasse miscelatore: cm 20.

Single-lever mixer for sink, with side lever, high C movable spout with pull-out hand shower, two functions.

Material: mixer and spout in c.p. brass, hand shower in c.p. abs.

Spout: shape 180°, swivelling, Ø mm 35.

Mixer interaxis: cm 20.





Q 72
Miscelatore monocomando con base quadrata.
Single-lever mixer with squared body.



N 72
Miscelatore monocomando con base tonda.
Single-lever mixer with round body.

Miscelatore monocomando laterale per lavello, alto, con bocca a U girevole.

Materiale: miscelatore in ottone cromato.

Canna: forma a 180°, girevole, Ø mm 24.

Interasse miscelatore: cm 21,5.

Single-lever mixer for sink, with side lever, high U movable spout.

Material: mixer and spout in c.p. brass.

Spout: shape 180°, swivelling, Ø mm 24.

Mixer interaxis: cm 21,5.



Q 86
Miscelatore monocomando con base quadrata.
Single-lever mixer with squared body.



N 86
Miscelatore monocomando con base tonda.
Single-lever mixer with round body.

Miscelatore monocomando laterale per lavello alto, con bocca a J girevole e doccetta estraibile a due funzioni.

Materiale: miscelatore in ottone cromato, doccetta in abs cromato.

Canna: forma a 155°, girevole, Ø 35 mm in ottone cromato.

Interasse miscelatore/doccetta: cm 20.

Single-lever mixer for sink, with side lever, high J movable spout, with pull-out hand shower, two functions.

Material: mixer and spout in C.P. brass, hand shower in Abs chrome plated.

Spout: shape 155°, swivelling Ø 35 mm.

Mixer interaxis: cm 20.





Q 75

Miscelatore monocomando con base quadrata.
Single-lever mixer with squared body.

Miscelatore monocomando laterale per lavello, alto, con bocca girevole a molla in acciaio inox elettrolucidata, flessibile in acciaio inox ricoperto in pvc metallizzato e doccetta monogetto.

Materiale: miscelatore in ottone cromato, doccetta in ottone cromato.

Interasse miscelatore: cm 20.



N 75

Miscelatore monocomando con base tonda.
Single-lever mixer with round body.

Single-lever mixer for sink, with side lever, high movable spring sput in stainless steel electro polished with shower.

Material: mixer in c.p. brass, spout in stainless steel with stainless steel flexible covered with silver colour pvc, hand shower in c.p. brass..

Mixer interaxis: cm 20.



LED LIGHT

NR 75 2

Miscelatore monocomando con base tonda e doccetta monogetto con luce led (per maggiori dettagli e scelta cromatica vedi serie Minimal Color a pag 104)

Single lever mixer with round base and led light one jet handshower (for more details and color choice pls see serie Minimal Color from page 104)

COLORI - COLOURS

A



La luce emanata è solo bianca
The light emitted is white only

B

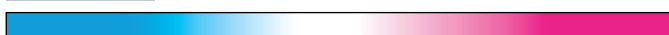

La luce emanata cambia colore al variare della temperatura

The light emitted changes color with temperature

Azzurro: fino a 28°
Bianco : da 28° a 38°
Rosa: da 38°

Light Blue : up to 28°
White: from 28° to 38°
Pink: from 38°

C



La luce emanata cambia colore al variare della temperatura

The light emitted changes color with temperature

Blu : fino a 28°
Verde : da 28° a 38°
Giallo: da 38° a 44°
Rosso: da 44°

Blue : up to 28°
Green: from 28° to 38°
Yellow: from 38° to 44°
Red: from 44°

D



Un arcobaleno di colori e sfumature si alternano creando un continuo gioco emozionale

A rainbow of colors and shades alternate, creating a constant emotional game

GOURMET



Q 77
Miscelatore monocomando con base quadrata.

Single-lever mixer with squared body.



N 77
Miscelatore monocomando con base tonda.

Single-lever mixer with round body.



LED LIGHT

NR 77 2
Miscelatore monocomando con base tonda e doccetta monogetto con luce led (per maggiori dettagli e scelta cromatica vedi serie Minimal Color a pag 104).

Single lever mixer with round base and led light one jet handshower (for more details and color choice pls see serie Minimal Color from page 104).

Miscelatore monocomando laterale per lavello alto, con bocca girevole a molla in acciaio inox elettrolucidata, flessibile e doccetta a due funzioni*.

Materiale: miscelatore in ottone cromato, molla in acciaio inox, flessibile in acciaio inox ricoperto in pvc metallizzato argento, doccetta in ottone cromato.

Altezza massima inclusa: molla cm 75.

Interasse miscelatore/doccetta: regolabile da cm 20 a cm 30 (regolazione sull'asta).

Single-lever mixer for sink, with side lever, high movable spring spout in stainless steel electro polished with hand shower, two functions*.

Material: mixer in c.p. brass, spring spout in stainless steel with stainless steel flexible covered with silver colour pvc, hand shower in c.p. brass.

Maximum height of the mixer, spring included: cm 75.

Interaxis mixer/shower: from cm 20 to cm 30 (adjustable on the rod).

COLORI LUCE A LED - LED LIGHT COLOURS

A

La luce emanata è solo bianca
The light emitted is white only

B

La luce emanata cambia colore al variare della temperatura
Azzurro: fino a 28°
Bianco: da 28° a 38°
Rosa: da 38°

The light emitted changes color with temperature
Light Blue: up to 28°
White: from 28° to 38°
Pink: from 38°

C

La luce emanata cambia colore al variare della temperatura
Blu: fino a 28°
Verde: da 28° a 38°
Giallo: da 38° a 44°
Rosso: da 44°

The light emitted changes color with temperature
Blue: up to 28°
Green: from 28° to 38°
Yellow: from 38° to 44°
Red: from 44°

D

Un arcobaleno di colori e sfumature si alternano creando un continuo gioco emozionale
A rainbow of colors and shades alternate, creating a constant emotional game



Q 78

Miscelatore monocomando con base quadrata.
Single-lever mixer with squared body.



N 78

Miscelatore monocomando con base tonda.
Single-lever mixer with round body.

Miscelatore monocomando laterale per lavello, alto, con doppia uscita dell'acqua e comando apertura-chiusura separato.

Canna girevole in ottone cromato e bocca girevole a molla in acciaio inox elettrolucidato con flessibile e doccetta a due funzioni.

Materiale: miscelatore in ottone cromato, molla in acciaio inox, flessibile in acciaio inox ricoperto in pvc metallizzato argento, doccetta in ottone cromato.

Altezza massima inclusa molla alta: cm 80

Interasse miscelatore/doccetta: regolabile da cm 20 a cm 30 (regolazione sull'asta).

Single-lever mixer for sink, with side lever, with double water outlet and opening/closing separate control.

Lower movable spout in c.p. brass and high movable spring spout in stainless steel electro polished with hand shower, two functions.

Material: mixer in c.p. brass, high spring spout in stainless steel with stainless steel flexible covered with silver colour pvc, hand shower in c.p. brass.

Maximum height of the mixer, spring included: cm 80.

Interaxis mixer/shower: adjustable from cm 20 to cm 30 (adjustable on the rod).

* per il modello con luce led è prevista una doccetta in ottone ad un solo getto più luce al led

* for the led light model the handshower will be outputting one jet plus led light



Q 87

Miscelatore monocomando con base quadrata.
Single-lever mixer with squared body.



N 87

Miscelatore monocomando con base tonda.
Single-lever mixer with round body.

Miscelatore monocomando laterale per lavello, alto, con bocca girevole a molla in acciaio inox elettrolucidato, flessibile e doccetta estraibile a due funzioni.

Materiale: miscelatore in ottone cromato, molla in acciaio inox, flessibile in acciaio inox, doccetta in ottone cromato.

Altezza massima inclusa molla alta: cm 75.

Interasse miscelatore/doccetta: regolabile da cm 20 a cm 30 (regolazione sull'asta).

Single-lever mixer for sink, with side lever, high movable spring spout in stainless steel electro polished with pull-out hand shower, two functions.

Material: mixer in c.p. brass, spring spout in stainless steel, with stainless steel flexible, hand shower in c.p. brass.

Maximum height of the mixer, spring included: cm 75.

Interaxis mixer/shower: adjustable from cm 20 to cm 30 (adjustable on the rod).



DJC



DJD



DJN

Articoli: N85, Q85, N77, Q77, N78, Q78, N87, Q87, anche disponibili con doccette in alternativa (vedi immagini a fianco). Inserire il suffisso DJC, DJD o DJN dopo il codice del prodotto per richiedere la doccetta differente da quella standard.

Articles: N85, Q85, N77, Q77, N78, Q78, N87, Q87, also available with alternative shower hands (see side images). To choose one of these handshowers instead of the standard one, add DJC, DJD or DJN after the article number.



BORRDO
LAVELLO
DECK SINK
MIXER





N 48 319 MO

Miscelatore monocomando bordo lavello serie Minimal con deviatore, bocca minimale e doccetta cromata minimale a 2 funzioni con getti in silicone, idromassaggio ed anticalcare.

Single lever deck sink mixer serie Minimal with diverter, with C.p. minimal handshower 2 functions hydromassage, anti-limestone with silicone jets.



N 48 332 EU

Miscelatore monocomando bordo lavello serie Minimal con deviatore, bocca minimale e doccetta a pulsante minimale in Abs cromata con impugnatura liscia 1/2".

Single lever deck sink mixer serie Minimal with diverter, with C.p. Abs minimal shut-off, with plain handgrip 1/2".



J 48 319 MO

Miscelatore monocomando bordo lavello serie Jazz con deviatore, bocca minimale e doccetta cromata minimale a 2 funzioni con getti in silicone, idromassaggio ed anticalcare.

Single lever deck sink mixer serie Jazz with diverter, with C.p. minimal handshower 2 functions hydromassage, anti-limestone with silicone jets.



J 48 332 EU

Miscelatore monocomando bordo lavello serie Jazz con deviatore, bocca minimale e doccetta a pulsante minimale in Abs cromata con impugnatura liscia 1/2".

Single lever deck sink mixer serie Jazz with diverter, with C.p. Abs minimal shut-off, with plain handgrip 1/2".

304 INOX



ACCIAIO INOX AISI 304 STAINLESS STEEL AISI 304

L'acciaio inox è il materiale per eccellenza più adatto al trasporto dell'acqua perché ne mantiene inalterate le caratteristiche fisiologiche e la purezza. Viene utilizzato nelle cucine industriali e nelle industrie alimentari essendo un materiale di prima scelta. lo propone anche per le abitazioni private come alternativa ancor più valida all'ottone.

Stainless steel is the best and more suitable material for the transportation of water because it keeps unchanged its physiological features and its pureness. Stainless steel is used in the industrial kitchens and in the food industries being a first choice material. suggests it also for private home use as an alternative even more valid than brass.



304 S44

Miscelatore monocomando per lavello con cartuccia ad apertura progressiva, completamente in acciaio inox AISI 304, forma minimale quadrata, con bocca alta girevole.

One-hole single-lever mixer for sink, with progressive opening cartridge, completely in stainless steel AISI 304, minimal squared shape, with high movable spout.



304 T42

Miscelatore monocomando per lavello, completamente in acciaio inox AISI 304, con bocca alta girevole tipo lusso.

Single-lever one-hole sink mixer, completely in stainless steel AISI 304, with high movable spout, luxury type.



304 X43

Miscelatore tradizionale monoforo maniglia a croce, completamente in acciaio inox AISI 304, con canna alta a C in tubo e girevole.

One-hole traditional sink mixer, completely in stainless steel AISI 304, with cross handles, high "C" movable spout.



304 T47

Miscelatore monocomando lavello, completamente in acciaio inox AISI 304, con doccia estraibile a getto variabile.

One-hole sink mixer, completely in stainless steel AISI 304, with pull out shower 2 functions

304 INOX





304 N72

Miscelatore monocomando per lavello, completamente in acciaio inox AISI 304, con leva laterale e canna in tubo piegato a U, girevole, forma minimale.

Single-lever one-hole sink mixer, completely in stainless steel AISI 304, with side lever and high tube "U" spout, movable, minimal shaped.



304 N77

Miscelatore monocomando laterale per lavello, completamente in acciaio inox AISI 304, alto, con bocca girevole a molla elettrolucidata, flessibile in acciaio inox ricoperto in pvc color argento e doccia a due funzioni in abs cromato.

Altezza massima inclusa molla: cm 75.

Interasse miscelatore/doccetta: 27 cm.

Single-lever mixer for sink with side lever, completely in stainless steel AISI 304, with high movable spring spout electro polished, flexible in stainless steel covered in silver colour pvc and hand shower, two functions, in c.p. abs.

Maximum height of the mixer, spring included: cm 75.

Interaxis mixer/shower: cm 27.

CUCINA
COUNTRY
COUNTRY
KITCHEN



Serie LIBERTY - LIBERTY Serie



43 LI A

Monoforo lavello con canna antica.
One hole sink mixer with "Antique" spout.



Disponibili anche con vitone ceramico; aggiungere CE alla fine del codice.

Available also with ceramic headvalve; add CE at the end of the article number.



63
VECCHIO OTTONE
OLD BRASS

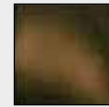

SM
OTTONE S. MARCO
S. MARCO BRASS



OM
V. OTTONE OPACO
MATT OLD BRASS



27
GRANITO BIANCO
CARRON
WHITE CARRON
GRANITE



25
GRANITO GRIGIO
CARRON
GREY CARRON
GRANITE



26
GRANITO GRIGIO
SINMAR
GREY SINMAR
GRANITE



62
CAPPUCCINO
CAPPUCCINO



60
TERRA DI FRANCIA
TERRA DI FRANCIA

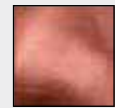

64
VECCHIO RAME
OLD COPPER



OIL
OIL BRONZE
OIL BRONZE



43 LI

Gruppo lavello monoforo canna girevole.
One-hole sink mixer with swivel spout.



43 LI J

Gruppo lavello monoforo con canna Jota in tubo.
One-hole sink mixer with swivel J tube spout.

TUTTO
CUCINA
KITCHEN





**Serie ATMOS
A 40**

Miscelatore monocomando per lavello completamente girevole.
Single lever one-hole sink mixer entirely turnable.



**Serie FLASH
Z 40**

Miscelatore monocomando per lavello con corpo girevole.
Single lever one-hole sink mixer with sivable body.



**Serie QUBIKA
Q 40**

Miscelatore monocomando per lavello, corpo quadrato e completamente girevole.

Single lever one-hole squared sink mixer with entirely movable body.



**Serie QUBIKA
Q 42 U**

Miscelatore monocomando per lavello, con bocca alta a "U" girevole.

Single-lever one-hole sink mixer, with high "U" movable spout.



**Serie SQ 3
S 40 3**

Miscelatore monocomando per lavello, corpo quadrato e completamente girevole.

Single lever one-hole squared sink mixer with entirely movable body.



**Serie SQ 3
S 42 U 3**

Miscelatore monocomando per lavello, con bocca alta a "U" girevole.

Single-lever one-hole sink mixer, with high "U" movable spout.



Serie MINIMAL

N 40

Miscelatore monocomando per lavello, con bocca girevole, altezza bocca mm 160, lunghezza bocca mm 200.

Single-lever one-hole sink mixer, with movable spout, height of spout mm 160, length of spout mm 200.

N 40 L

Come N 40 con altezza bocca mm 280.

As N 40, with height of spout mm 280.



Serie MINIMAL

N 47

Miscelatore monocomando per lavello, con bocca estraibile.

Single-lever one-hole sink mixer, with pull-out spray jet shower.



Serie JAZZ

J 40

Miscelatore monocomando per lavello, con bocca girevole.

Single-lever one-hole sink mixer, with movable spout.



Serie JAZZ

J 47

Miscelatore monocomando per lavello, con doccia estraibile in ottone cromato.

Single-lever one-hole sink mixer, with pull-out spray jet shower in c.p. brass.



Serie FUTURA

U 42 2

Monocomando lavello con bocca alta girevole.

Single lever kitchen mixer with high movable spout.



Serie FUTURA

U 47 2

Monocomando lavello con bocca alta girevole e doccetta estraibile.

Single lever kitchen mixer with high movable spout, with pull out spray.



Serie FUTURA

U 40

Miscelatore monocomando per lavello, con bocca girevole.

Single-lever one-hole sink mixer, with movable spout.



Serie BLUE



B 40

Miscelatore monocomando per lavello, con bocca girevole.

Single-lever one-hole sink mixer, with movable spout.

TUTTO CUCINA



Caratteristiche Tecniche

- Rotazione della manopola: 330° angolari
- Blocco di sicurezza: 38°C
- Campo di lavoro: da 5°C a 80°C
- Differenziale termico consigliato 50°C
- Campo di pressione in rete: da 1 a 10 bar (consigliato da 1 a 5 bar dinamici)
- Sistema di sicurezza con blocco dell'erogazione in caso di mancanza di una delle due acque
- Alta erogazione (circa 30 litri) in uscita libera
- Filtri in acciaio inox per il trattamento delle impurità

I termostatici serie si caratterizza-
no inoltre per la loro migliore funzionalità;
difatti, al contrario della maggior parte del-
la rubinetteria termostatica in commercio,
l'apertura dell'acqua (funzione usata quoti-
dianamente) avviene tramite la maniglia de-
stra mentre il settaggio della temperatura
(funzione usata più sporadicamente) avvie-
ne tramite la manopola sinistra. Nonostan-
te la produzione delle serie sia tecnicamen-
te più difficile, siamo sicuri di dare ai nostri
clienti un prodotto ancor più valido.

Technical data

- Handle rotation: 330° angular
- Safety lock: 38°C
- Working field: from 5°C to 80°C
- Suggested thermic differential between cold and hot water: 50°C
- Pressure field: from 1 to 10 bar (suggested from 1 to 5 bar dynamic)
- Safety system with the outlet lock in case there is one water lock
- High flow rate (about 30 liters) in free outlet
- Stainless steel filters to keep the impurity

Thermostatic mixers serie features are
further characterised by the best functionality.
In fact, contrary to the main part of other
producers thermostatics, in line the
opening of the water flow (function used daily)
has been studied to be positioned on the right
lever while the temperature setting (function
used more rarely) is positioned on the left
lever. Even if Serie's production becomes for
this reason technically more difficult, we are
sure to give to our customers a product even
more valuable.

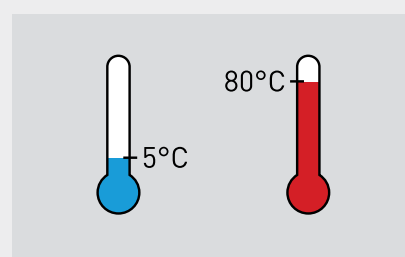
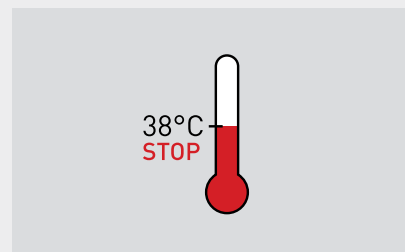
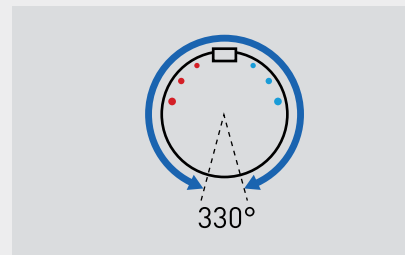

Serie EAGLE E 40

Miscelatore termostatico per lavello con pulsante di sicurezza a 38° e bocca alta girevole fusa tipo lusso.

Thermostatic sink mixer with 38° safety push button and high movable casted spout, luxury type.



THERMOSTATIC

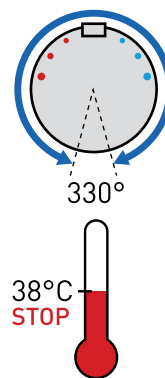

Serie THERMO H 40

Miscelatore lavello termostatico.







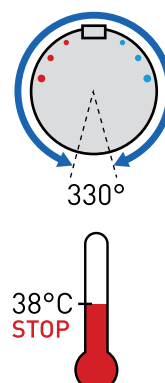

























Thermostatic sink mixer.



































THERMOSTATIC



TUTTO CUCINA

SERIE	PROJECT Ø 40	TEN Ø 40	GIGA Ø 40	GIGA 4 Ø 40
Miscelatore monocomando per lavello, con bocca girevole. Single-lever one-hole sink mixer, with movable spout.	 P 40	 T 40	 G 40	 G 40 4
Miscelatore monocomando per lavello, con doccia estraibile a getto variabile. Single-lever one-hole sink mixer, with pull-out spray jet shower, with 2 functions.	 P 47	 T 47	 G 47	 G 47 4
Miscelatore monocomando per lavabo o lavello, con bocca girevole. Single-lever one-hole basin or sink mixer, with movable spout.				
Miscelatore monocomando per lavello, con bocca alta girevole. Single-lever one-hole sink mixer with high movable spout.	 P 42	 T 42	 G 42	 G 42 4
Miscelatore monocomando per lavello, con bocca alta girevole a "C", tipo lusso, modello corto. Single-lever one-hole sink mixer with "C" high movable spout, luxury type, shorter model.	 P 42 C	 T 42 C	 G 42 C	 G 42 C 4
Miscelatore monocomando per lavello, con bocca alta a "U" girevole. Single-lever one-hole sink mixer, with high "U" movable spout.	 P 42 U	 T 42 U	 G 42 U	 G 42 U 4
Miscelatore monocomando per lavello a muro, con bocca girevole. Single-lever wall mounted sink mixer, with movable spout.	 P 41	 T 41	 G 41	 G 41 4
Miscelatore monocomando per lavello a muro, con bocca a "S" girevole. Single-lever wall mounted sink mixer, with "S" movable spout.	 P 41 S	 T 41 S	 G 41 S	 G 41 S 4
Miscelatore monocomando per lavello, con bocca alta girevole, tipo lusso. Single-lever one-hole sink mixer, with high movable spout, luxury type.	 P 42 R	 T 42 R	 G 42 R	 G 42 R 4

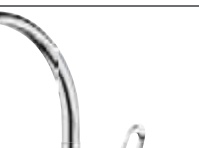
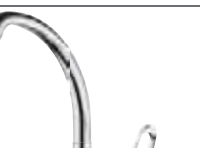
ALL KITCHEN

MUSA Ø 40	KISS Ø 40	REMIX Ø 35	35 Ø 35
 M 40	 K 40	 R 40	 F 40 2
 M 47	 K 47		
	 K 11 G	 R 11 G	 F 11 2 G
 M 42	 K 42	 R 42	 F 42 2
 M 42 C	 K 42 C	 R 42 C	 F 42 C 2
 M 42 U	 K 42 U	 R 42 U	 F 42 2 U
 M 41	 K 41	 R 41	 F 41
 M 41 S	 K 41 S	 R 41 S	 F 41 S
 M 42 R	 K 42 R	 R 42 R	 F 42 R

LIBERTY TRADIZIONALE



43 LI

Gruppo lavello monoforo canna girevole.

One-hole sink mixer with swivel spout.

Disponibile anche con vitone ceramico; aggiungere CE alla fine del codice.



Available also with ceramic headvalve; add CE at the end of the article number.



43 LI J

Gruppo lavello monoforo con canna Jota in tubo.

One-hole sink mixer with swivel J tube spout.

Disponibile anche con vitone ceramico; aggiungere CE alla fine del codice.



Available also with ceramic headvalve; add CE at the end of the article number.



SENSOR

Le linee di rubinetteria a sensore si distinguono per eleganza e prestazioni. L'eleganza delle linee è garantita dall'accurato studio di design che sta alla base di ogni sviluppo.

L'ingegnerizzazione e produzione viene eseguita interamente in Italia dagli ingegneri e tecnici del Gruppo tramite macchinari di ultimissima generazione, completamente automatizzati e robotizzati. Ogni pezzo è un gioiello di design e tecnologia delle costruzioni.

L'elettronica viene prodotta anch'essa in Italia da S.T.S.R., leader nella produzione di cartucce, vitoni ceramici, termostatici, dotata di un dipartimento di elettronica molto all'avanguardia e rinomato nel settore proprio per l'affidabilità e la durata nel tempo dei suoi prodotti.

The sensor taps series of are distinguished by their elegance and performance. The elegance of the lines is guaranteed by the accurate design at the base of any development.

The engineering and manufacturing are performed entirely in Italy by engineers and technicians of Group, through machinery of the latest generation, fully automated and robotized. Every single piece is a jewel of design and construction technology.

The electronics and sensors are also produced in Italy from S.T.S.R., leader Company in ceramic cartridges, headvalves and thermostatics production, which is equipped with an electronics very enhanced department, well renowned in our field for the reliability and durability of its products.



SE 18

Miscelatore elettronico lavabo ad azionamento a sensore, con regolazione acqua caldo/freddo.

Sensor control basin mixer with hot/cold water adjustment lever.

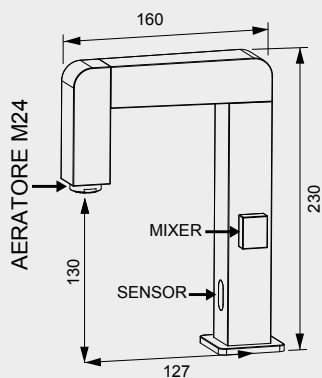

DATI TECNICI:

- Pressione di lavoro: 1 → 8 Bar
 - Temperatura acqua: 80° C max
 - Diametro di entrata: Ø G 1/2 M
 - Raggio d'azione di riconoscimento: 10 cm, predisposto
 - Alimentazione elettrica: 4 batterie da 1,5 V tipo AA
 - Durata delle batterie: 2/3 anni.
 - Portabatterie adesivizzabile IP67.
 - 2 modalità di funzionamento selezionabili (basso consumo/alta reattività).
 - Omologazione CE.
 - Connessioni IP67.
- Funzionamento esteso al settore industriale.

TECHNICAL DATA:

- Working pressure: 1-5 Bar
 - Water temperature max: 80° C max
 - Input: Ø G 1/2 M
 - Recognition range: 10 cm adjustable
 - Electrical connection: 4 1,5 V batteries type AA
 - Batteries life: 2/3 years.
 - Adhesive Battery Holder IP67.
 - 2 selectable operation modes. (low-consumption/high reactivity)
 - CE approved.
 - IP67 connections.
- Extended operation to the industrial sector.



EN61000-6-2(2007)
EN61000-6-3(2007) + A1 (2011)



SENSOR

LED LIGHT



SE 18R

Miscelatore elettronico lavabo ad azionamento a sensore, con luce led e con regolazione acqua caldo/freddo.

Sensor control basin mixer, with led and with hot/cold water adjustment lever.

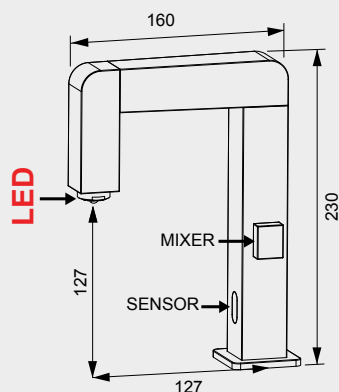

DATI TECNICI:

- Pressione di lavoro: 1 → 8 Bar
 - Temperatura acqua: 80° C max
 - Diametro di entrata: Ø G 1/2 M
 - Raggio d'azione di riconoscimento: 10 cm, predisposto
 - Alimentazione elettrica: 4 batterie da 1,5 V tipo AA
 - Durata delle batterie: 2/3 anni.
 - Portabatterie adesivizzabile IP67.
 - 2 modalità di funzionamento selezionabili (basso consumo/alta reattività).
 - Omologazione CE.
 - Connessioni IP67.
- Funzionamento esteso al settore industriale.

TECHNICAL DATA:

- Working pressure: 1-5 Bar
 - Water temperature max: 80° C max
 - Input: Ø G 1/2 M
 - Recognition range: 10 cm adjustable
 - Electrical connection: 4 1,5 V batteries type AA
 - Batteries life: 2/3 years.
 - Adhesive Battery Holder IP67.
 - 2 selectable operation modes. (low-consumption/high reactivity)
 - CE approved.
 - IP67 connections.
- Extended operation to the industrial sector.



EN61000-6-2(2007)
EN61000-6-3(2007) + A1 (2011)



CARATTERISTICHE TECNICHE:

La cartuccia Color è prodotta in Italia da S.T.S.R., certificata CE ed interamente a norma.

Tutte le parti elettriche ed elettroniche sono perfettamente isolate dall'acqua garantendo un perfetto funzionamento a lungo termine. La cartuccia è dotata anche di filtro in entrata che permette alla turbina di lavorare isolata dalle impurità presenti nell'acqua ed alla cartuccia di essere pulita tipo un normale aeratore.

L'intensità della luce non dipende dalla pressione dell'acqua e la cartuccia Color si aziona a 2.5lt/min

TECHNICAL CHARACTERISTICS:

The Color cartridge is produced in Italy by S.T.S.R. and certified CE.

All the electrical and electronical parts are perfectly isolated from water guaranteeing a long term perfect performance.

The cartridge is equipped with an inlet filter that prevent any dirt to get into the turbine, the cartidge can be cleaned likly a normal aerator.

The color intensity does not depend on water pressure and the colortherapy cartridge starts performing at 2.5lt/m.

Il prodotto è disponibile in quattro varianti denominate A, B, C, D, di seguito dettagliate. Per evidenziare la Vostra scelta, aggiungere la lettera corrispondente a fine codice articolo.

The product is available in four variants named A, B, C, D, that we detail here following. To highlight your selection please add the choosen letter at the end of the article number.

A



La luce emanata è solo bianca
The light emitted is white only

B



La luce emanata cambia colore al variare della temperatura

The light emitted changes color with temperature

Azzurro: fino a 32°
Bianco : da 32° a 38°
Rosa: oltre 38°

Light Blue : up to 32°
White: from 32° to 38°
Pink: from 38°



C



La luce emanata cambia colore al variare della temperatura

The light emitted changes color with temperature

Blu : fino a 28°
Verde : da 28° a 33°
Giallo: da 33° a 38°
Rosso: da 38°

Blue : up to 28°
Green: from 28° to 33°
Yellow: from 33° to 38°
Red: from 38°



D



Un arcobaleno di colori e sfumature si alternano creando un continuo gioco emozionale

A rainbow of colors and shades alternate, creating a constant emotional game



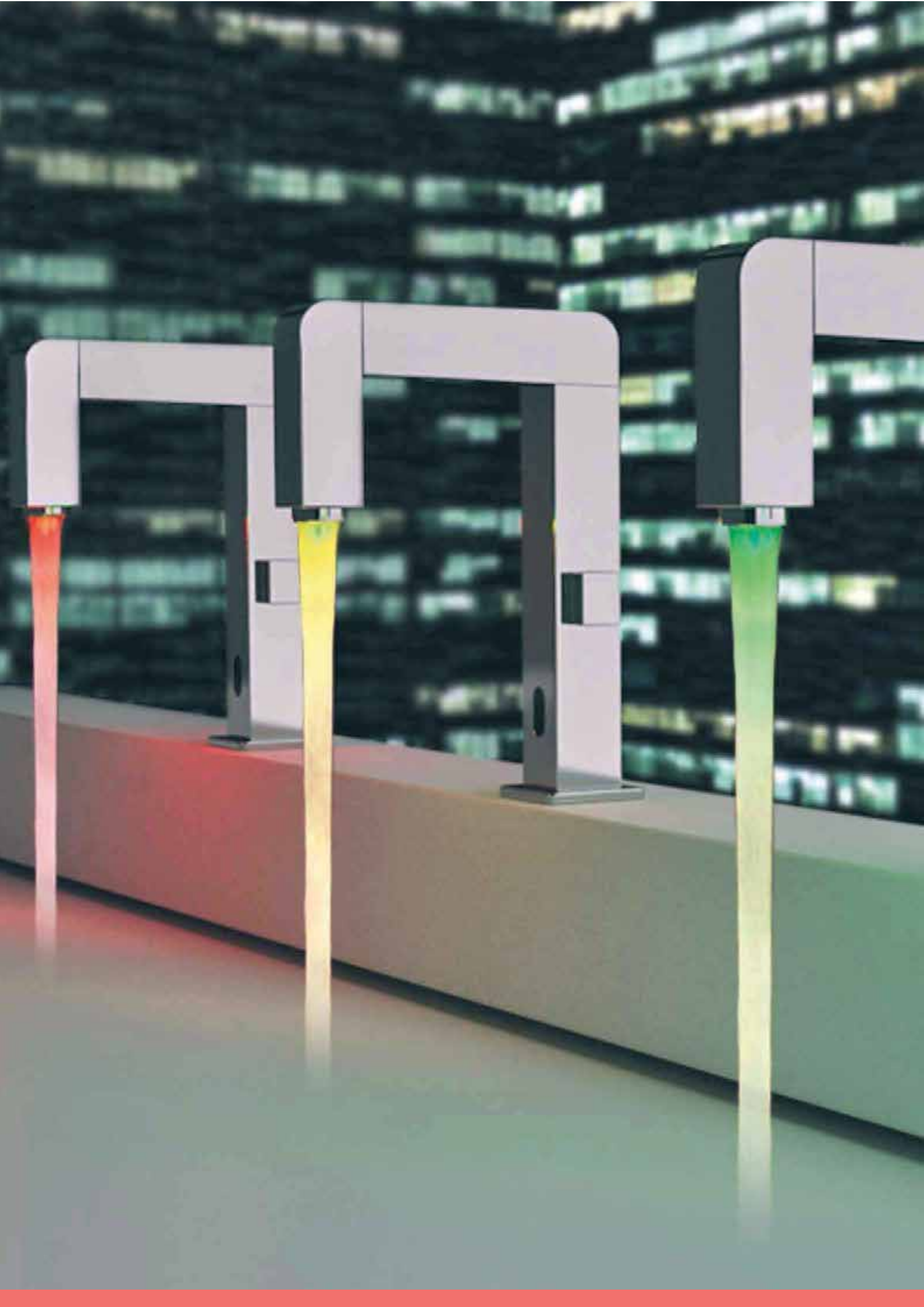

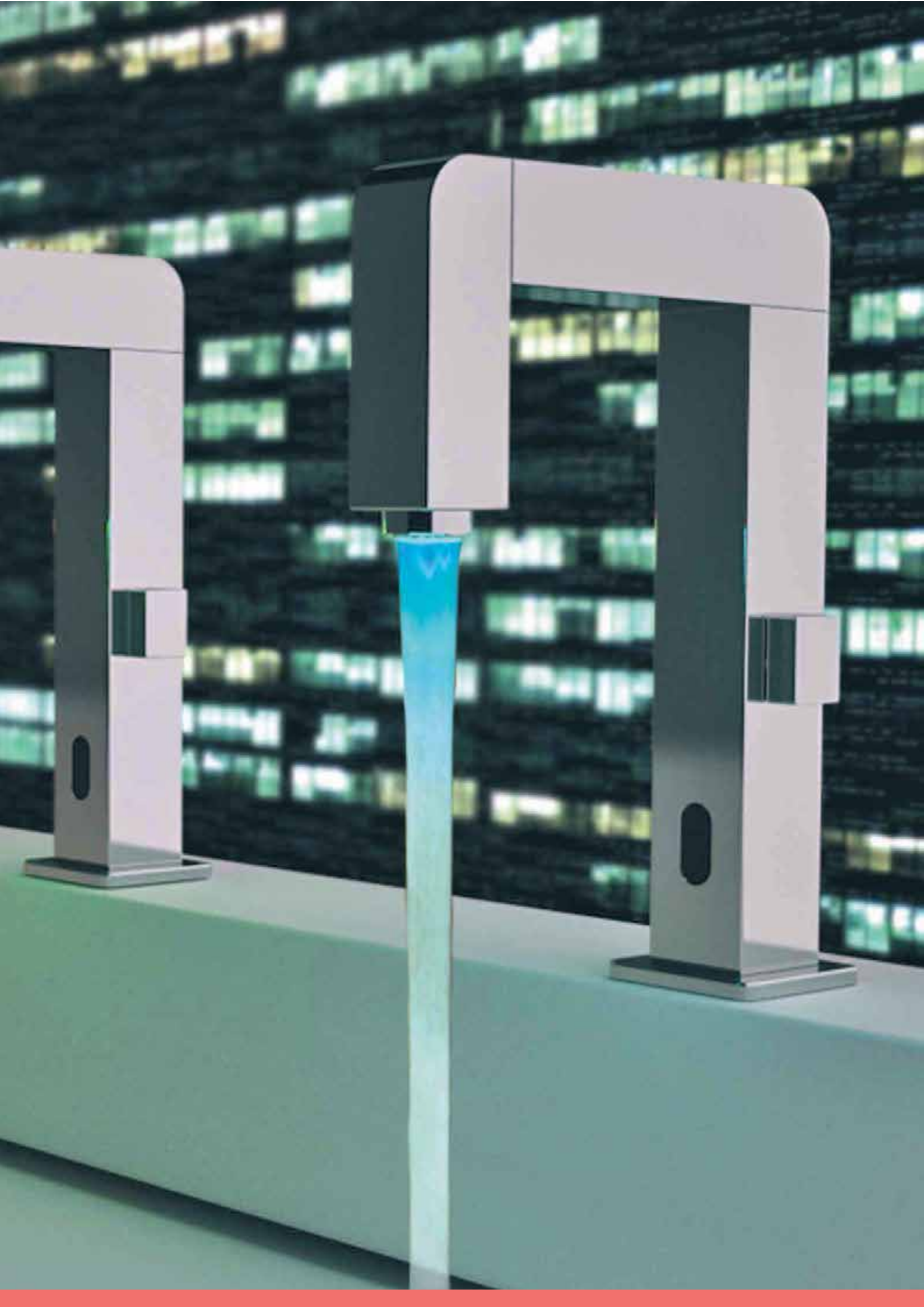

SENSOR



SE 17

Miscelatore elettronico lavabo ad azionamento a sensore, con regolazione temperatura tramite rubinetto sottolavabo.

Sensor control basin mixer, with temperature control on angle valve.

CE EN61000-6-2(2007)
EN61000-6-3(2007) + A1 (2011)



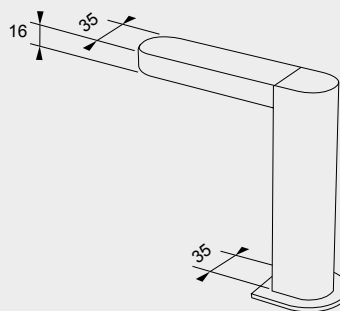
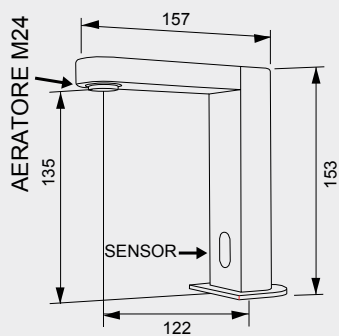

DATI TECNICI:

- Pressione di lavoro: 1 → 8 Bar
- Temperatura acqua: 80° C max
- Diametro di entrata: Ø G 1/2 M
- Raggio d'azione di riconoscimento: 10 cm, predisposto
- Alimentazione elettrica: 4 batterie da 1,5 V tipo AA
- Durata delle batterie: 2/3 anni.
- Portabatterie adesivizzabile IP67.
- 2 modalità di funzionamento selezionabili (basso consumo/alta reattività).
- Omologazione CE.
- Connessioni IP67.

Funzionamento esteso al settore industriale.

TECHNICAL DATA:

- Working pressure: 1-5 Bar
- Watertemperature max: 80° C max
- Input: Ø G 1/2 M
- Recognition range: 10 cm adjustable
- Electrical connection: 4 1,5 V batteries type AA
- Batteries life: 2/3 years.
- Adhesive Battery Holder IP67.
- 2 selectable operation modes. (low-consumption/high reactivity)
- CE approved.
- IP67 connections.

Extended operation to the industrial sector.





SE 15

Rubinetto elettronico con azionamento a sensore ad acqua singola.

Sensor control basin tap with single water.

 EN61000-6-2(2007)
EN61000-6-3(2007) + A1 (2011)

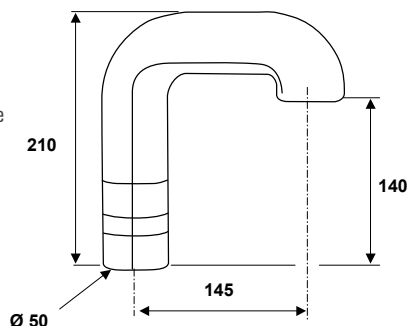

DATI TECNICI:

- Pressione di lavoro: 1 → 8 Bar
 - Temperatura acqua: 80° C max
 - Diametro di entrata: Ø G 1/2 M
 - Raggio d'azione di riconoscimento: 10 cm, predisposto
 - Alimentazione elettrica: 4 batterie da 1,5 V tipo AA
 - Durata delle batterie: 2/3 anni.
 - Portabatterie adesivizzabile IP67.
 - 2 modalità di funzionamento selezionabili (basso consumo/alta reattività).
 - Omologazione CE.
 - Connessioni IP67.
- Funzionamento esteso al settore industriale.

TECHNICAL DATA:

- Working pressure: 1-5 Bar
 - Water temperature max: 80° C max
 - Input: Ø G 1/2 M
 - Recognition range: 10 cm adjustable
 - Electrical connection: 4 1,5 V batteries type AA
 - Batteries life: 2/3 years.
 - Adhesive Battery Holder IP67.
 - 2 selectable operation modes. (low-consumption/high reactivity)
 - CE approved.
 - IP67 connections.
- Extended operation to the industrial sector.

SE 15B

Rubinetto elettronico ad azionamento a sensore ad acqua singola con basetta.

Sensor control basin tap with single water and with base.

 EN61000-6-2(2007)
EN61000-6-3(2007) + A1 (2011)

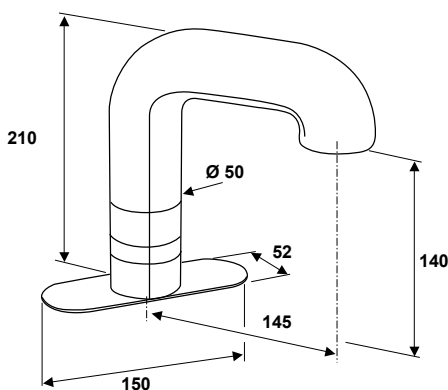

DATI TECNICI:

- Pressione di lavoro: 1 → 8 Bar
 - Temperatura acqua: 80° C max
 - Diametro di entrata: Ø G 1/2 M
 - Raggio d'azione di riconoscimento: 10 cm, predisposto
 - Alimentazione elettrica: 4 batterie da 1,5 V tipo AA
 - Durata delle batterie: 2/3 anni.
 - Portabatterie adesivizzabile IP67.
 - 2 modalità di funzionamento selezionabili (basso consumo/alta reattività).
 - Omologazione CE.
 - Connessioni IP67.
- Funzionamento esteso al settore industriale.

TECHNICAL DATA:

- Working pressure: 1-5 Bar
 - Water temperature max: 80° C max
 - Input: Ø G 1/2 M
 - Recognition range: 10 cm adjustable
 - Electrical connection: 4 1,5 V batteries type AA
 - Batteries life: 2/3 years.
 - Adhesive Battery Holder IP67.
 - 2 selectable operation modes. (low-consumption/high reactivity)
 - CE approved.
 - IP67 connections.
- Extended operation to the industrial sector.

SE 14

Miscelatore elettronico ad azionamento a sensore, con regolazione acqua caldo/freddo.

Sensor control mixer, with hot/cold water adjustment lever.

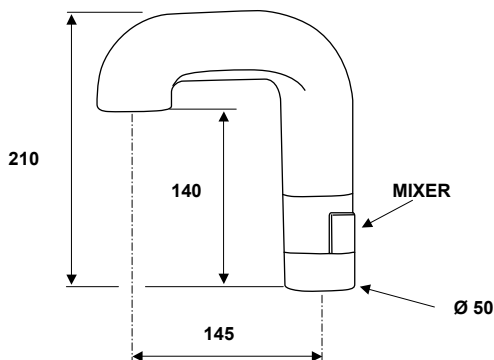
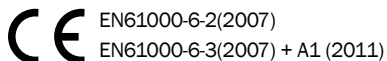

DATI TECNICI:

- Pressione di lavoro: 1 → 8 Bar
 - Temperatura acqua: 80° C max
 - Diametro di entrata: Ø G 1/2 M
 - Raggio d'azione di riconoscimento: 10 cm, predisposto
 - Alimentazione elettrica: 4 batterie da 1,5 V tipo AA
 - Durata delle batterie: 2/3 anni.
 - Portabatterie adesivizzabile IP67.
 - 2 modalità di funzionamento selezionabili (basso consumo/alta reattività).
 - Omologazione CE.
 - Conessioni IP67.
- Funzionamento esteso al settore industriale.

TECHNICAL DATA:

- Working pressure: 1-5 Bar
 - Water temperature max: 80° C max
 - Input: Ø G 1/2 M
 - Recognition range: 10 cm adjustable
 - Electrical connection: 4 1,5 V batteries type AA
 - Batteries life: 2/3 years.
 - Adhesive Battery Holder IP67.
 - 2 selectable operation modes. (low-consumption/high reactivity)
 - CE approved.
 - IP67 connections.
- Extended operation to the industrial sector.

SE 14B

Miscelatore elettronico ad azionamento a sensore con regolazione acqua caldo/freddo con bassetta.

Sensor control mixer, with hot/cold water adjustment lever with base.

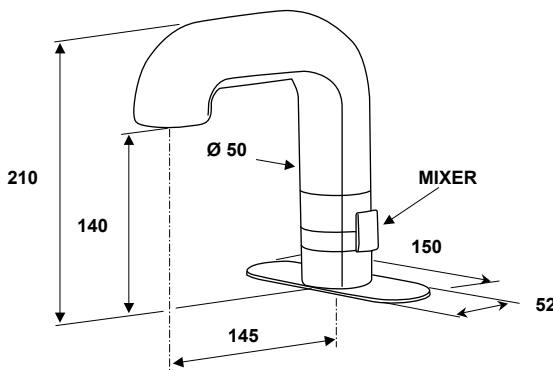
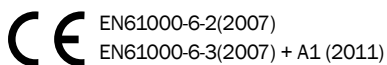

DATI TECNICI:

- Pressione di lavoro: 1 → 8 Bar
 - Temperatura acqua: 80° C max
 - Diametro di entrata: Ø G 1/2 M
 - Raggio d'azione di riconoscimento: 10 cm, predisposto
 - Alimentazione elettrica: 4 batterie da 1,5 V tipo AA
 - Durata delle batterie: 2/3 anni.
 - Portabatterie adesivizzabile IP67.
 - 2 modalità di funzionamento selezionabili (basso consumo/alta reattività).
 - Omologazione CE.
 - Conessioni IP67.
- Funzionamento esteso al settore industriale.

TECHNICAL DATA:

- Working pressure: 1-5 Bar
 - Water temperature max: 80° C max
 - Input: Ø G 1/2 M
 - Recognition range: 10 cm adjustable
 - Electrical connection: 4 1,5 V batteries type AA
 - Batteries life: 2/3 years.
 - Adhesive Battery Holder IP67.
 - 2 selectable operation modes. (low-consumption/high reactivity)
 - CE approved.
 - IP67 connections.
- Extended operation to the industrial sector.



Tutti i prodotti sono soggetti a modifiche senza alcun preavviso. Le informazioni e i materiali contenuti in queste pagine sono soggetti a modifiche.

All products are subject to change without notice. Information and materials included in these pages are subject to change.

SE 30

Rubinetto elettronico a incasso per orinatoio.
Urinal electronic wall-mounted flusher.

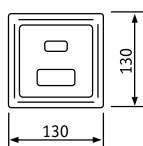

Dati Tecnici

- Pressione di lavoro: 1 - 6 Bar
- Diametro di entrata: G1/2
- Azionamento: elettrovalvola integrata
- Raggio d'azione di riconoscimento: 30 - 60 cm, regolabile
- Alimentazione elettrica: DC 4.5V tre batterie alcaline "AAA" da 1.5V
- Installazione: montaggio a muro.

Technical Data

- Working pressure: 1 - 6 Bar
- Input: Ø G 1/2
- Control valve: solenoid valve
- Recognition range: 30-60 cm adjustable
- Electrical connection: DC 4.5 V with 3 1.5 V alkaline batteries type AAA
- Installation: wall mounted

SE 33

Rubinetto elettronico esterno per orinatoio.
Urinal electronic external flusher.

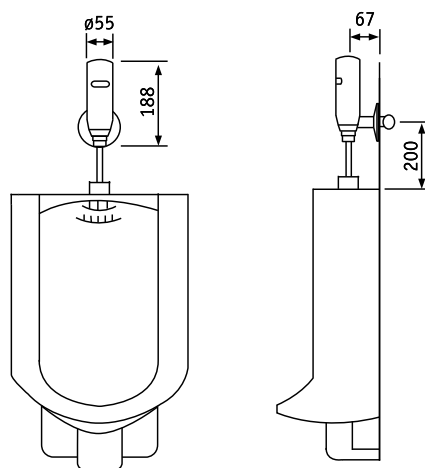

Dati Tecnici

- Pressione di lavoro: 1 - 6 Bar
- Diametro di entrata: G1/2
- Raggio d'azione di riconoscimento: 35 cm, predisposto
- Alimentazione elettrica: DC 6V quattro batterie alcaline "AAA" da 1.5V
- Durata delle batterie: più di un anno
- Modalità di installazione: esterno

Technical Data

- Working pressure: 1 - 6 Bar
- Input: Ø G 1/2
- Recognition range: 35 cm adjustable
- Electrical connection: DC 6V with 4 1.5 V alkaline batteries type AAA
- Batteries life: more than one year
- Installation: external mounted

SE 70

Distributore elettronico di sapone.
Electronic liquid soap dispenser.

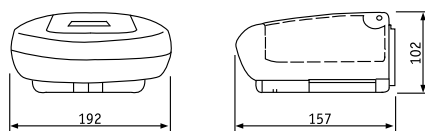

Dati Tecnici

- Capacità: 300 c.c.
- Alimentazione elettrica: DC 6V quattro batterie alcaline "AAA" da 1.5V
- Durata della batteria: 35-50000 cicli (Risultante da test continui, alimentati da batterie alcaline da 6V. Soggetta alla densità del sapone liquido)
- Raggio d'azione: 70 - 120 mm
- Alimentazione/ciclo: 1.0 c.c.
- Tempo di ritardo: 1 - 1.5 secondi

Technical Data

- Capacity: 300 c.c.
- Electrical connection: DC 6V with 4 1.5 V alkaline batteries type AAA
- Batteries life: 2 years with 35-50.000 cycles a year depending on liquid density
- Recognition range: 7-12 cm adjustable
- Liquid/cycle: 1.0 c.c.
- Lag time: 1 - 1.5 seconds



TEMPOR

In ambienti pubblici la rubinetteria temporizzata rende un servizio importante in termini di risparmio idrico e razionalizzazione dell'uso dell'acqua. I rubinetti della serie Tempor sono articoli funzionali e ben lavorati, si caratterizzano di design diversi per vestire adeguatamente ogni soluzione estetica, sia essa di design, moderna o più tradizionale.

In public places the temporised – timer mixers give an important service in terms of water saving and rationalisation of the use of water. Serie Tempor taps are functional items well worked, are characterised of different designs to wear properly every aesthetical solution, of design, modern or more traditional.



TE 15

Rubinetto temporizzato a collo cigno, 1/2", in ottone cromato, tempo d'apertura 6-8 secondi.

Temporized (timer) pillar tap, 1/2", all in c.p. brass, opening time 6-8 seconds.



TE 16

Rubinetto temporizzato a collo cigno, 1/2", in ottone cromato, tempo d'apertura 6-8 secondi.

Temporized (timer) pillar tap, 1/2", all in c.p. brass, opening time 6-8 seconds.



TE 18

Rubinetto temporizzato a collo cigno, Minimal, 1/2", in ottone cromato, tempo d'apertura 6-8 secondi.

Temporized (timer) pillar tap, 1/2", Minimal, all in c.p. brass, opening time 6-8 seconds.



TE 18 M

Rubinetto miscelatore temporizzato a collo cigno con maniglia per la selezione dell'acqua calda/ fredda, serie minimal, 1/2", in ottone cromato, tempo di apertura 6-8 secondi.

Temporized (timer) mixer pillar tap with hot/cold water selection handle, serie minimal. 1/2", in c.p. brass, opening time 6-8 seconds.

**TE 19**

Rubinetto temporizzato serie SQ a collo cigno, 1/2", in ottone cromato, tempo d'apertura 6-8 secondi.

Temporized (timer) pillar tap serie SQ, 1/2", all in c.p. brass, opening time 6-8 seconds.

**TE 20**

Rubinetto temporizzato a collo cigno, 1/2", in ottone cromato, tempo d'apertura 6-8 secondi.

Temporized (timer) pillar tap, 1/2", all in c.p. brass, opening time 6-8 seconds.

**TE 22**

Rubinetto temporizzato 1/2", linea ovale in ottone cromato tempo d'apertura 6-8 secondi.

Temporized tap 1/2", oval line all in Cp brass opening time 6-8 seconds.

**TE 53**

Rubinetto frontale temporizzato, con canna "S", 1/2", in ottone cromato, tempo d'apertura 6-8 secondi.

Temporized (timer) frontal mounted, with "S" spout, 1/2" tap, all in c.p. brass, opening time 6-8 seconds.

**TE 225**

Rubinetto frontale temporizzato, 1/2", in ottone cromato, tempo d'apertura 6-8 secondi.

Temporized (timer) frontal mounted 1/2" tap, all in c.p. brass, opening time 6-8 seconds.

**TE 42 S**

Rubinetto superiore temporizzato, con canna "U", 1/2", in ottone cromato, tempo d'apertura 6-8 secondi.

Temporized (timer) upper mounted, with "U" spout, 1/2" tap, all in c.p. brass, opening time 6-8 seconds.

**TE 42**

Rubinetto superiore temporizzato, con canna "J", 1/2", in ottone cromato, tempo d'apertura 6-8 secondi.

Temporized (timer) upper mounted, with "J" spout, 1/2" tap, all in c.p. brass, opening time 6-8 seconds.



TE 53 329EX 351 EX

Rubinetto frontale temporizzato, colonna doccia 1/2" x 3/4" e soffione doccia standard, tempo d'apertura 25 secondi.

Temporized (timer) frontal mounted, with stand pipe 1/2" x 3/4" and standard shower rose, opening time 25 seconds.



TE VI

Cartuccia di ricambio per rubinetti temporizzati art. TE 15, TE 16, TE 53, TE 225, TE 855.

Spare cartridge for temporized (timer) taps art. TE 15, TE 16, TE 53, TE 225, TE 855.

TE VI 30

Cartuccia di ricambio per rubinetti temporizzati art. TE 30.

Spare cartridge for temporized (timer) taps art. TE 30.



TE 31

Rubinetto temporizzato a pulsante per doccia esterno, 1/2"x1/2", in ottone cromato, tempo d'apertura 18-20 secondi.

Temporized (timer) tap for shower, 1/2"x1/2", external, all in c.p. brass, opening time 18-20 seconds.



TE 30

Rubinetto per doccia incasso temporizzato, 1/2", tempo d'apertura 18-20 secondi.

Temporized (timer) wall mounted tap, 1/2", opening time 18-20 seconds.



332 TEL

Set composto da: doccia a pulsante, flessibile conico cm 120, rubinetto temporizzato 1/2" in ottone cromato, tempo d'apertura 6-8 secondi.

Set composto da: shut-off handshower, flessibile cm 120, temporized button flusher 1/2" all in c.p. brass, opening time 6-8 seconds.



TE 855

Rubinetto temporizzato a pulsante per orinatoio, 1/2", in ottone cromato, completo di rosoni, di due tubetti Ø mm 14 e guarnizione. Tempo d'apertura 6-8 secondi.

Temporized (timer) urinal button flusher, 1/2", in c.p. brass, in a set with flanges, two copper tubes Ø mm 14 and a washer. Opening time 6-8 seconds.



TE 856

Rubinetto temporizzato a pulsante per orinatoio, serie SQ, 1/2", in ottone cromato, completo di rosoni, di due tubetti Ø mm 14 e guarnizione. Tempo d'apertura 6-8 secondi.

Temporized (timer) urinal button flusher serie SQ, 1/2", in c.p. brass, in a set with flanges, two copper tubes Ø mm 14 and a washer. Opening time 6-8 seconds.



TE 170

Flussometro temporizzato a pulsante esterno per WC, in ottone cromato, tempo d'apertura 5-6 secondi, misure: 3/4, 1".

Temporized (timer) wall mounted tap, for wc, all in c.p. brass, opening time 5-6 seconds: 3/4, 1".



TE 171

Flussometro temporizzato a incasso, a pulsante, per wc, 3/4, 1", tempo d'apertura 6-8 secondi.

Temporized (timer) built-in tap, for wc, 3/4, 1", opening time 6-8 seconds.



170 TU

Tubo a "L" per Flussometro esterno, in ottone cromato, Ø 25, 30.

"L" c.p. brass pipe, for wall mounted tempor tap for wc, Ø 25, 30.



856

Spartiacque per orinatoio, attacco Ø 15, con tubo Ø 15 mm.

Water divide for urinals, connection Ø 15, with pipe Ø 15 mm.



ACCESSORI
PER
RUBINETTERIA

TAPS
ACCESSORIES



ACCESSORI PER RUBINETTERIA



61
Rubinetto prolungato con comando a gomito, 1/2.
Wall mounted long tap, 1/2, with long lever.



63
Rubinetto a snodo con comando a gomito, 1/2, con canna inferiore.
Wall mounted hose-holder tap, 1/2, with long lever and S inferior spout.



64
Gruppo lavello con comando a gomito e canna inferiore.
Wall mounted mixer, with long levers and S inferior spout.



14 LL
Gruppo lavello tipo a ponte con comando a gomito e canna Ø 18 mm.
Sink mixer bridge type, with long lever and spout Ø 18 mm.



65
Rubinetto collo cigno con comando a gomito, 1/2.
Wash basin pillar tap, 1/2, with long lever.



61 LE
Leva in ottone cromato per articoli 61, 63, 64, 65, 14LL.
Lever for art. 61, 63, 64, 65, 14LL.

61 VI
Vitone da 1/2 per articoli 61, 63, 64, 65, 14LL.
Head valve 1/2 for articles 61, 63, 64, 65, 14LL.

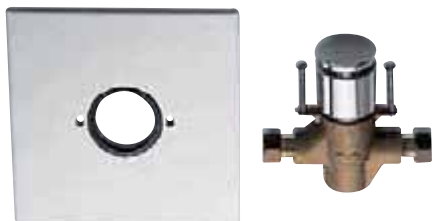

66

Rubinetto a pedale ad incasso in ottone cromato.
Built in tap foot operated, in c.p. brass.



66 MP

Rubinetto-miscelatore pedaliera universale. Può essere installato sia a parete che a pavimento.

Treadle mixer with universal pedal control. It can be installed both on the wall and on the floor.



67

Bocca a snodo per lavello.
Movable spout for washbasin.



69

Rubinetto a pulsante a zampillo parabolico per refrigeratore o depuratore. Regolazione del getto sotto il pulsante.

Parabolic jet button tap for refrigerator or purifier. Water flow control under the button.

ACCESSORI PER RUBINETTERIA



S 50

Cartuccia Ø mm 40 a dischi in ceramica per vasca, lavabo, bidet (tipo con distributori).

Ceramic cartridge Ø 40 mm for bath, wash basin, bidet (type with distributor).



S 52

Cartuccia Ø mm 40 a dischi in ceramica per lavello, doccia (tipo piatto).

Ceramic cartridge Ø 40 mm for sink and shower (flat bottom type).



R 50

Cartuccia Ø mm 35 a dischi in ceramica per vasca, lavabo, bidet (tipo con distributori).

Ceramic cartridge Ø 35 mm for bath, wash basin, bidet (type with distributor).



R 52

Cartuccia Ø mm 35 a dischi in ceramica per lavello, doccia (tipo piatto).

Ceramic cartridge Ø 35 mm for sink and shower (flat bottom type).



S 50 AF

Cartuccia ad apertura forzata Ø mm 40 a dischi ceramici per vasca, lavabo, bidet (tipo con distributori) permette un notevole risparmio idrico.

Forced opening ceramic cartridge Ø 40 mm for bath, wash basin, bidet (type with distributors) permit a remarkable saving of water.

CLICK SYSTEM



S 52 AF

Cartuccia ad apertura forzata Ø mm 40 a dischi ceramici per lavello, doccia (tipo piatto) permette un notevole risparmio idrico.

Forced opening ceramic cartridge Ø 40 mm for sink, shower (flat bottom type) permit a remarkable saving of water.



R 50 AF

Cartuccia ad apertura forzata Ø 35 mm a dischi ceramici per vasca, lavabo, bidet (tipo con distributori) permette un notevole risparmio idrico.

Forced opening ceramic cartridge Ø 35 mm for bath, wash basin, bidet (type with distributors) permit a remarkable saving of water.

CLICK SYSTEM



R 52 AF

Cartuccia ad apertura forzata Ø 35 mm a dischi ceramici per lavello, doccia (tipo piatto) permette un notevole risparmio idrico.

Forced opening ceramic cartridge Ø 35 mm for sink, shower (flat bottom type) permit a remarkable saving of water.



P 50

Cartuccia progressiva Ø 35, con distributori, con chiusura del flusso e uscita dell'acqua verso il basso.

Ceramic cartridge Ø 35, with distributors, with flow shut-off and water outlet towards the low.



P 52

Cartuccia progressiva Ø 35, senza distributori, con chiusura del flusso e uscita dell'acqua verso il basso.

Ceramic cartridge Ø 35, without distributors, with flow shut-off and water outlet towards the low.



V 50 C

Cartuccia a dischi ceramici Ø 25 mm, tipo piatto

Ceramic cartridge Ø 25 mm, flat bottom type



V 50 A

Cartuccia a dischi ceramici Ø 25, con uscita dell'acqua direttamente dalla parte alta dell'involucro a cilindro senza quindi essere riconvogliato verso il fondo della cartuccia.

Ceramic discs cartridge Ø 25, with water outlet directly from the top part of the cylindric shell without being joined towards the bottom of the cartridge.



J 50

Cartuccia a dischi ceramici Ø mm 35, movimento a "joystick", tipo piatto.

Ceramic cartridge Ø 35 mm, "joystick" movement, flat bottom type

ACCESSORI PER RUBINETTERIA



Q 34 DEV 5

Deviatore a 5 posizioni per doccia (1 via in entrata e 5 vie in uscita) serie Qubika.

Shower 5 outlet way diverter (1 inlet way and 5 outlet ways) for Qubika serie.



N 34 DEV 5

Deviatore a 5 posizioni per doccia (1 via in entrata e 5 vie in uscita) serie Minimal.

Shower 5 outlet way diverter (1 inlet way and 5 outlet ways) for Minimal serie.



Q 93 DEV 3

Deviatore a tre vie (una entrata e tre uscite) su piastra, serie qubika.

Three ways diverter (1 inlet and 3 outlets) on flange, qubika serie.

Q 93 DEV 7

Deviatore a tre vie e sette posizioni (una entrata, tre uscite e sette posizioni con cui selezionare uscite singole o miscelate tra loro) su piastra, serie qubika.

Scatti della maniglia-deviatore:

- lo scatto 1 aziona l'acqua dell'uscita 1
- lo scatto 2 aziona l'acqua dell'uscita 2
- lo scatto 3 aziona l'acqua dell'uscita 3
- lo scatto 4 aziona l'acqua dell'uscita 1
- lo scatto 5 aziona l'acqua delle uscite 1 + 2
- lo scatto 6 aziona l'acqua delle uscite 1 + 2 + 3
- lo scatto 7 aziona l'acqua delle uscite 2 + 3

Three ways diverter with seven positions (1 inlet and 3 outlets and seven positions to select single or mixed outlets) on flange, qubika serie.

Handle steps of the diverter :

- 1st step to run water from outlet 1
- 2nd step to run water from outlet 2
- 3rd step to run water from outlet 3
- 4th step to run water from outlet 1
- 5th step to run water from outlets 1 + 2
- 6th step to run water from outlets 1 + 2 + 3
- 7th step to run water from outlets 2 + 3



N 93 DEV 3

Deviatore a tre vie (una entrata e tre uscite) su piastra, serie minimal.

Three ways diverter (1 inlet and 3 outlets) on flange, minimal serie.

N 93 DEV 7

Deviatore a tre vie e sette posizioni (una entrata, tre uscite e sette posizioni con cui selezionare uscite singole o miscelate tra loro) su piastra, serie minimal.

Scatti della maniglia-deviatore:

- lo scatto 1 aziona l'acqua dell'uscita 1
- lo scatto 2 aziona l'acqua dell'uscita 2
- lo scatto 3 aziona l'acqua dell'uscita 3
- lo scatto 4 aziona l'acqua dell'uscita 1
- lo scatto 5 aziona l'acqua delle uscite 1 + 2
- lo scatto 6 aziona l'acqua delle uscite 1 + 2 + 3
- lo scatto 7 aziona l'acqua delle uscite 2 + 3

Three ways diverter with seven positions (1 inlet and 3 outlets and seven positions to select single or mixed outlets) on flange, minimal serie.

Handle steps of the diverter :

- 1st step to run water from outlet 1
- 2nd step to run water from outlet 2
- 3rd step to run water from outlet 3
- 4th step to run water from outlet 1
- 5th step to run water from outlets 1 + 2
- 6th step to run water from outlets 1 + 2 + 3
- 7th step to run water from outlets 2 + 3



K 09 PROL

Prolunga per corpo monocomando doccia incasso con deviatore per cartuccia Ø 40 mm.

Extention for built-in shower mixer body with diverter for cartridge Ø 40 mm.



N 09 PROL

Prolunga per corpo monocomando doccia incasso con deviatore per cartuccia Ø 35 mm.

Extention for built-in shower mixer body with diverter for cartridge Ø 35 mm.



S 52 PROL

Prolunga per corpo monocomando doccia incasso con cartuccia Ø 40 mm.

Extention for built-in shower mixer body with cartridge Ø 40 mm.



R 52 PROL

Prolunga per corpo monocomando doccia incasso con cartuccia Ø 35 mm.

Extention for built-in shower mixer body with cartridge Ø 35 mm.



E 50

Cartuccia termostatica con rotazione manopola a 330° angolari, blocco di sicurezza a 38°C, campo di lavoro da 5°C a 80°C, campo di pressione da 1 a 10 bar, filtro inox e sistema di sicurezza con blocco dell'erogazione in caso di mancanza di una delle due acque.

Thermostatic cartridge with 330° angular handle rotation, 38° safety lock, working field from 5°C to 80°C, pressure field from 1 to 10 bar, stainless steel filter and safety system with the outlet lock in case there is one water lock.



75

Vitone universale per rubinetti, che permette di ottenere 102 combinazioni di misure e lunghezze. Confezione skin-pack.

Universal headvalve for taps, allow to create 102 different combinations of lengths and sizes. Packed in a safe skin-pack.

ACCESSORI PER RUBINETTERIA



74

Vitone da 1/2 per gruppo vasca, lavello, batteria lavabo, rubinetto bidet e incasso per art. 53, 55.

Head valve 1/2" for bath, sink, wash basin, bidet and built-in stop cock for art. 53, 55.



74 E

Come 74, tipo leggero.

As 74, light type.



74 F

Vitone da 1/2 con filetto per coprivitone M24x1.

Head valve 1/2 with thread M24x1 for head valve cover.



76 DX

Vitone 90° a dischi ceramici, broccia Ø 8 mm, 20 denti, destro, e mm 8, 24 denti, destro.

Head valve 90° ceramic discs, broach Ø 8 mm, 20 teeth, right, and broach Ø 8 mm, 24 teeth, right.



76 SX

Come 76 SX, ma sinistro.

As 76 SX, but left.



76 DX 180

Vitone 180° a dischi ceramici, broccia Ø mm 8, 20 denti, destro.

Head valve 180° ceramic discs, broach Ø 8 mm, 20 teeth, right.



77 18

Vitone filetto 18/19 per art. 221, 223, 224, 250, 252 e altri.

18/19 Head valve thread for art. 221, 223, 224, 250, 252 and others.

77 3/8

Vitone con filetto 3/8, per rubinetti.

3/8 Head valve thread, for taps.



77 19

Vitone con filetto 19/19, per rubinetti incasso.

19/19 Head valve thread, for built-in stop cocks.



78

Vite fissa maniglia.
Screw for fixing handle.



80 SN

Morsetto con vite per scarico automatico.
Joint with screw for pop-up waste.



DEV 00

Deviatore in ottone automatico con molla e fermo per basse pressioni.

Automatic brass diverter with spring and lock for low pressure.



DEV 08

Deviatore in ottone automatico con molla e fermo, con prolunga 8 mm.

Automatic brass diverter with spring and lock, mm 8 extended in 1/2 side.



DEV 13

Deviatore in ottone automatico con molla e fermo, con prolunga 13 mm.

Automatic brass diverter with spring and lock, mm 13 extended in 1/2 side.

ACCESSORI PER RUBINETTERIA



81 A

Aeratore anticalcare ad alta tecnologia F22, brevettato e di lunghissima durata, scocca in ottone ed interno in materiale plastico innovativo a forte resistenza.

High technology anti-limestone aerator F22, patented and long-lasting, shell in c.p. brass, internal in innovative plastic material very resistant.



83 A

Aeratore anticalcare ad alta tecnologia M24, brevettato e di lunghissima durata, scocca in ottone ed interno in materiale plastico innovativo a forte resistenza.

High technology anti-limestone aerator M24, patented and long-lasting, shell in c.p. brass, internal in innovative plastic material very resistant.



83 C

Chiave brevettata per la pulizia settimanale degli aeratori ad alta tecnologia art. 81 A e art. 83 A.

Patented key for the weekly cleaning of the high technology aerators art. 81 A and 83 A.



81

Aeratore classico con retine in inox, per gruppo lavello F22.

Classic aerator with inox nets, for sink spout F22.



83

Aeratore classico con retine in inox, per lavabo, lavello e bidet M24.

Classic aerator with inox nets, for basin, bidet and sink, M24.



84

Aeratore per gruppo vasca, M28.

Aerator for bath mixer, M28.



81 SN

Snodo attacco F22 con ghiera M22.

Joint F22 and nut M22.



83 SN

Snodo attacco M22 con ghiera M24.

Joint M22 and nut M24.



83 N41

Aeratore M18.

Aerator M18.



85

Aeratore con snodo per monoforo bidet, M24.

Balljoint aerator for one-hole bidet, M24.



81 RD 12

Riduzione 1/2MxM22. Consente di collegare qualsiasi attacco da 1/2F", esempio tutti i flessibili doccia, con un aeratore standard lavabo/lavello F22, vedi ns articolo 81 (al posto di una doccetta o di uno shut off). Allo stesso modo consente di collegare al lavabo/lavello un qualsiasi flessibile doccia.

Reduction 1/2MxM22. Allows to connect any 1/2F" connection, for example all the shower flexibles, with a standard aerator basin/sink F22, see our art. 81 (instead of the classic handshower or shut-off).

In the same way allows to connect to the basin/sink any shower flexible.



83 RD 12

Riduzione 1/2MxF24. Consente di collegare qualsiasi attacco da 1/2F", esempio tutti i flessibili doccia, con un aeratore standard lavabo M24, vedi ns articolo 83 (al posto di una doccetta o di uno shut off). Allo stesso modo consente di collegare al lavabo un qualsiasi flessibile doccia.

Reduction 1/2MxF24. Allows to connect any 1/2F" connection, for example all the shower flexibles, with a standard aerator basin M24, see our art. 83 (instead of the classic handshower or shut-off).

In the same way allows to connect to the basin any shower flexible.



83 NE SI

Aeratore Neoperl autopulente M24X1 con erogatore in silicone morbido anticalcare per una pulizia manuale semplificata.

Neoperl aerator selfcleaning M24X1 with silicon antilimestone bottom, for soft simplified handcleaning.



83 NE

Aeratore Neoperl effetto a scomparsa, con tecnologia in silicone autopulente per una pulizia veloce dal calcare, con filetto M24X1 che puo' essere sostituito senza difficoltà a tutte le rubinetterie con filettatura per aeratore M24X1.

Molto indicato per modelli di design quali Qubika, Minimal, SQ.

Neoperl aerator with built-in effect, with silicon anti-limestone technology for an easier cleaning, M24X1 thread, can be easily substituted to all the standard mixers with M24X1 aerators.

Very indicated for design models like Qubika, Minimal SQ.



83 NE BA

Aeratore Neoperl M24X1 con getto direzionabile tramite terminale basculante, permette con il semplice tocco della parte inferiore dell'aeratore di dirigere il flusso della direzione desiderata.

Neoperl aerator M24X1 with movable aerator bottom that, with the simple touch, permits to move the flow to the preferred direction.



82

Aeroflux a due getti, con doccetta a snodo, filetto F22 con riduzione M24.

Double spray aerator, with balljoint shower, thread F22 with reduction M24.



82 DJ

Aeroflux "Dual Jet" in ottone cromato a due getti, con doccetta a snodo e filetto F22.

Double spray c.p. brass shower-aerator "Dual Jet", with ball-joint shower, thread F22.



82 UN

Aeroflux a due getti, con doccetta a snodo, con attacco universale.

Double spray aerator, with balljoint shower, with standard connection.



82 L

Aeroflux a due getti, con manicotto a vite, lunghezza cm 15.

Double spray aerator, with screw standard connection, length 15 cm.



82 LGH

Aeroflux a due getti, con ghiera e filetto F22, lunghezza 15 cm.

Double spray aerator, with nut and thread F22, length 15 cm.



83 L6 - 83 L8

Aeratore lavabo e bidet M24, per risparmio idrico con limitatore di portata da 6 litri al minuto (art. 83 L6) o da 8 litri al minuto (art. 83 L8).

Aerator for wash basin and bidet mixers, M24, water saving, with reduction of consumption and excellent flow at 6 litres by minute (art. 83 L6) or 8 liters by minute (art. 83 L8).



83 AVC

Kit antivandalico e anticalcare composto da aeratore speciale per miscelatori lavabo e bidet M24 e chiave di montaggio, manutenzione e pulizia settimanale, ad alta tecnologia, brevettata.

Anti-vandalism and anti-limestone kit, composed by special aerator for wash basin and bidet mixers M24 and assembly, caring and weekly cleaning key, high technology and patented.



83 AVC L6 - 83 AVC L8

Kit come sopra, più risparmio idrico, che include anche limitatore di portata da 6 litri al minuto, art 83AVC L6, o limitatore di portata da 8 litri al minuto, art 83 AVC L8.

Kit same as above, plus water saving, that also includes one reduction of water consumption at 6 liters by minute, art 83 AVC L6, or one reduction of water consumption at 8 liters by minute, art 83 AVC L8.

83 SET L6 - 83 SET L8

Set risparmio idrico totale composto da raccordo doccia 1/2" in ottone cromato a portata limitata, aeratore lavabo e bidet M24 a portata limitata e chiave di montaggio manutenzione e pulizia settimanale, ad alta tecnologia, brevettata. Il kit e' disponibile in varianti da 6 litri al minuto (cod 83 SET L6) o 8 litri al minuto (cod 83 SET L8).

Total water saving set, composed by 1/2" shower connection with reduced flow in c.p. brass, wash basin and bidet aerator with reduced flow and assembling, caring and weekly cleaning key, high technology, patented. This set is available with outlet flow of 6 liters by minute (cod 83 SET L6) or 8 liters by minute (cod 83 SET L8).



309R L6 - 309R L8

Raccordo doccia 1/2" a risparmio idrico con limitatore di portata da 6 litri al minuto (art 309 L6) o 8 litri al minuto (art 309 L8).

C.p. brass connection, water saving program with flow reduction at 6 liters by minute (art 309 L6) or 8 liters by minute (art 309 L8).



662 FI 12

Guarnizione da 1/2" con filtro retinato anti-impurità.
1/2" washer with net filter, anti-impurity.



662 RE 12

Guarnizione da 1/2" a passaggio ridotto, con risparmio idrico del 30%.
1/2" washer, reduced flow, water saving 30%.

KIT PULIZIA AERATORE CLEANING KIT WITH AERATOR



83 SET 01

Set completo di 3 aeratori anticalcare M24 ad alta tecnologia + 1 chiave per la pulizia settimanale, brevettati e di lunghissima durata, il tutto in ottone cromato e materiale plastico innovativo a forte resistenza, confezionato in un tubo contenitore rigido e trasparente adatto per essere appeso. La chiave è stata studiata per pulire il calcare dall'aeratore in un solo semplice movimento.

Set complete of 3 anti-limestone M24 aerators of high technology + 1 weekly cleaning key, patented and extremely long lasting, all in c.p. brass and innovative plastic material very resistant, packed in a holding hard and transparent tube, suitable to be hung. The key has been studied to clean the aerator in one simple, easy movement.



83 SET 02

Idem come sopra ma con 2 aeratori anticalcare M24 e 1 aeratore anticalcare F22.

Same as above but with 2 anti-limestone M24 aerators and 1 anti-limestone F22 aerator.



81 AC

Set completo di 1 aeratore F22 anticalcare ad alta tecnologia + 1 chiave di pulizia settimanale, brevettati e di lunghissima durata, il tutto in ottone cromato e materiale plastico innovativo a forte resistenza. L'aeratore e la chiave sono stati studiati per pulire il calcare dall'aeratore in un solo semplice movimento.

Set complete of 1 anti-limestone F22 aerators of high technology + 1 weekly cleaning key, Patented and extremely long lasting, all in c.p. brass and innovative plastic material very resistant. The aerator and the key has been studied to clean the aerator in one simple, easy movement.



83 AC

Come 81 AC, ma con 1 aeratore M24.

As 81 AC, but with M24 aerator.

ACCESSORI PER RUBINETTERIA



88

Colonna per bordo vasca in ottone cromato, 1/2M x 3/4M.
C.P. brass vertical connection for bath mixer, 1/2M x 3/4M.

88 BI

Colonna per bordo vasca, verniciata bianca, 1/2M x 3/4M.
Vertical connection for bath mixer in white colour, 1/2M x 3/4M.



88 01 LI

Coppia colonne vasca in ottone cromato, serie Liberty, 3/4M x 3/4M.
Couple c.p. brass vertical connections for bath mixer, serie Liberty, 3/4M x 3/4M.



88 UK

Coppia colonnette bordo vasca in ottone cromato, serie UK, 3/4M x 3/4M.
Couple c.p. brass vertical connections for bath mixer, serie UK, 3/4M x 3/4M.



88 LI

Coppia colonnette bordo vasca in ottone cromato, serie Liberty, 3/4M x 3/4M.
Couple c.p. brass vertical connections for bath mixer, serie Liberty, 3/4M x 3/4M.



89

Eccentrico per gruppi, 1/2 x 3/4, con rosone in ottone cromato.
Eccentric unions for mixers, 1/2 x 3/4, with C.P. brass flange.

89 L

Eccentrico per gruppi, 1/2x3/4, tipo Lusso, con rosone in ottone cromato.
Eccentric unions for mixers, 1/2x3/4, with C.P. brass flange, luxury type.



89 N

Eccentrico per gruppi, 1/2 x 3/4, con rosone minimale in ottone cromato.
Eccentric unions for mixers, 1/2 x 3/4, with minimal C.P. brass flange.



90

Distanziatore per gruppi, 1/2x3/4, lunghezza cm.4, 6, 8.
C.P. brass S-connection for mixers, 1/2x3/4, length 4, 6, 8 cm.



ACCESSORI PER RUBINETTERIA



91 NC

Bocca incasso cascata con bordi arrotondati, serie Minimal.
Cascade built-in spout with rounded corners, Minima serie.



91 NCF

Bocca bordo vasca con effetto multigetto ed angoli arrotondati, serie Minimal.
Spout for deck bath/shower multijets effect and rounded corners, Minima serie.



91 NR

Bocca incasso cm 18, serie Minimal Color.
Minimal Color built-in spout, cm 18.



91 UF07

Bocca bordo vasca con getto a cascata.
Spout for deck bath/shower with waterfall jet.



91 M

Bocca incasso cm 18, serie Minimal.
Minimal built-in spout, cm 18.



91 MD

Bocca incasso serie Minimal, cm 18, con deviatore integrato.
Minimal built-in spout cm 18, with diverter.



91

Bocca incasso vasca-doccia.
Built-in spout for bath-shower.



91 D

Bocca incasso vasca-doccia, con deviatore integrato.
Built-in spout for bath-shower, with diverter.



91 ZCA

Bocca bordo vasca getto a cascata, serie Flash.
Spout for deck bath/shower with waterfall jet, Flash serie.



91 ZCF

Bocca bordo vasca con effetto multigetto serie Flash.
Spout for deck bath/shower with multijets effect, Flash serie.



91 QC

Bocca incasso cascata serie Qubika, cm 18.
Qubika cascade built-in spout Qubika series, cm 18.



91 ZC

Bocca incasso cascata, serie Flash.
Cascade built-in spout, Flash serie.



91 QR

Bocca incasso con luce led serie Q Color.
Built-in spout with led light Q Color Serie.



91 Q

Bocca incasso serie Qubika, cm 18.
Qubika built-in spout cm 18.



91 QD

Bocca incasso serie Qubika, cm 18, con deviatore integrato.
Qubika built-in spout, with diverter.



91 S

Bocca incasso quadrata cm 18, serie Square.
Square built-in spout, cm 18.



91 SD

Bocca incasso quadrata cm 18, serie Square con deviatore.
Square built-in spout cm 18, with diverter.

ACCESSORI PER RUBINETTERIA



325 07

Supporto per doccia estraibile per bordo lavello e bordo vasca, modello a base tonda.

Support for extensible handshower for deck bath and deck sink, round base model.



325 S 07

Supporto dritto per doccia estraibile per bordo lavello e bordo vasca, modello a base quadra.

Straight support for extensible handshower for deck bath and deck sink, squared base model.



86

Canna lavello inferiore a "S", tipo universale, con aeratore.

Lower "S" sink spout, universal type, with aerator.



86 N

Canna lavello inferiore a "S", cm 20, con aeratore.

Lower "S" sink spout, cm 20, with aerator.

86 N 40

Canna lavello inferiore a "S", cm 40, con aeratore.

Lower "S" sink spout, cm 40, with aerator.



86 U

Canna lavello superiore a "U", cm 20, con aeratore.

Upper "U" sink spout, cm 20, with aerator.



87 N

Canna a "J" per monoforo lavello, con aeratore.

"J" spout for one-hole sink, with aerator.



87

Canna a "J" per monoforo lavello, tipo universale, con aeratore.

"J" spout for one-hole sink, universal type, with aerator.



92 16

Canna a biscotto dritta, calotta da 3/4, lunghezza cm.16, con aeratore.

Straight spout with 3/4 nut, 16 cm long, with aerator.

92 20

Come 92 16, lunghezza cm 20.

Same as 92 16, 20 cm long.

92 30

Come 92 16, lunghezza cm 30.

Same as 92 16, 30 cm long.

92 40

Come 92 16, lunghezza cm 40.

Same as 92 16, 40 cm long.

92 50

Come 92 16, lunghezza cm 50.

Same as 92 16, 50 cm long.



92 S16

Canna a biscotto a "S", calotta da 3/4, lunghezza cm.16, con aeratore.

"S" spout with 3/4 nut, 16 cm long, with aerator.

92 S20

Come 92 S16, lunghezza cm 20.

As 92 S16, 20 cm long.

92 S30

Come 92 S16, lunghezza cm 30.

As 92 S16, 30 cm long.



92 C

Canna a biscotto a "C" con calotta da 3/4, con aeratore.

"C" spout with nut 3/4, with aerator.



92 CC

Canna a biscotto a "C" con calotta da 3/4, con aeratore, tipo corto.

"C" spout with nut 3/4, with aerator, short type.



92 U

Canna a "U" Ø 22, con aeratore.

"U" spout Ø 22, with aerator.



93

Canna fusa lunga cm 30 con deviatore, con calotta da 3/4 ed aeratore.

Casted cm 30 long spout with diverter, with 3/4 nut, with aerator.

ACCESSORI PER RUBINETTERIA



95 TA

Tappo scarico automatico in ottone per piletta 1" e per piletta 1"1/4.

C.p. brass plug for pop-up waste for drain 1" and for drain 1"1/4.



96 TA

Tappo in ottone cromato per colonna vasca automatica.

C.p. brass plug for automatic bath waste and overflow.



95 TAG

Tappo grande in ottone cromato per scarico automatico con piletta da 1"1/4.

Big plug in c.p. brass for pop-up waste with drain 1"1/4.



95 TAS

Tappo grande quadrato in ottone cromato per scarico automatico con piletta da 1"1/4.

Squared big plug in c.p. brass for pop-up waste with drain 1"1/4.



BA K10

Basetta in ottone per rubinetteria tipo serie Kiss, Ten, Giga.

Base in c.p. brass for mixers like serie Kiss, Ten, Giga.



94

Asta per scarico automatico, lunghezza cm 30, in ottone cromato.

Rod for pop-up waste, length 30 cm, in c.p. brass.



95 AC

Asta e centralina bidet per scarico automatico, in ottone cromato.

Rod and flange for bidet for pop-up automatic waste, in c.p. brass.



AS T10

Asta con pomolo e snodino per serie Ten, in ottone cromato.

Rod with knob and small joint for Ten series, in c.p. brass.



AS K10

Asta con pomolo e snodino per serie Kiss, in ottone cromato.

Rod with knob and small joint for Kiss series, in c.p. brass.



FIS K10

Confezione di fissaggio per art. K10, K20, K40.

Fixing set for art. K10, K20, K40.



FIS R10

Confezione di fissaggio per art. R10, R20, R40.

Fixing set for art. R10, R20, R40.



FIS T10

Confezione di fissaggio a doppio tirante.

Fixing set with double screw.



95
 Scarico automatico 1", 1"1/4.
 C.P. brass pop-up waste, 1", 1"1/4.



95 L
 Scarico automatico da 1"1/4, tipo Lusso.
 C.P. brass pop-up waste 1"1/4, luxury type.



95 U
 Scarico automatico da 1"1/4, tipo lusso lucidato.
 C.P. polished pop-up waste, 1"1/4, luxury type.



95 UG
 Scarico automatico da 1"1/4, tipo lusso lucidato, con tappo grande a copertura totale della piletta.
 C.P. polished pop-up waste, 1"1/4, luxury type with big plug covering the drain.



95 US
 Scarico automatico da 1"1/4, tipo lusso lucidato, con tappo grande quadrato piatto a copertura totale della piletta.
 C.p. polished pop-up waste, 1"1/4, luxury type with big squared flat plug covering the drain.



95 P
 Scarico automatico in plastica da 1"1/4.
 Plastic pop-up waste, 1"1/4.



95 AM
 Scarico tipo America o Americano, in ottone pulito e cromato.
 C.p. waste model America or American, polished and in c.p. brass.

ACCESSORI PER RUBINETTERIA



904 CC 2

Scarico automatico con sistema click-clack, 1"1/4, e tappo grande, senza troppo pieno, modello con bicchiere corto.

Automatic pop-waste, click-clack system, 1"1/4, big plug, without overflow, model with shorter cup.



904 SCC 2

Scarico automatico quadrato 1"1/4 con click-clack senza troppo pieno, modello con bicchiere corto.

Squared automatic pop-up waste 1"1/4 with click-clack system without overflow, model with shorter cup.



905 CC 2

Scarico automatico con sistema click-clack, 1"1/4, e tappo grande, con troppo pieno, modello con bicchiere corto.

Automatic pop-waste, click-clack system, 1"1/4, big plug, with overflow, model with shorter cup.



905 SCC 2

Scarico automatico quadrato 1"1/4 con click-clack con troppo pieno, modello con bicchiere corto.

Squared automatic pop-up waste 1"1/4 with click-clack system with overflow, model with shorter cup.



906 CC 2

Scarico automatico con sistema click-clack, 1"1/4, con troppo pieno, modello con bicchiere corto.

Automatic pop-waste, click-clack system, 1"1/4, with overflow, model with shorter cup.



907 2

Scarico automatico 1"1/4 con tappo grande sempre aperto e sistema click-clack per la pulizia interna, modello con bicchiere corto.

Automatic pop-up waste 1"1/4 with big plug always opened, and click-clack system for internal cleaning, model with shorter cup.



904 CC

Scarico automatico con sistema click-clack, 1"1/4, e tappo grande, senza troppo pieno.

Automatic pop-waste, click-clack system, 1"1/4, big plug, without overflow.



904 SCC

Scarico automatico quadrato 1"1/4 con click-clack senza troppo pieno.

Squared automatic pop-up waste 1"1/4 with click-clack system without overflow.



905 CC

Scarico automatico con sistema click-clack, 1"1/4, e tappo grande, con troppo pieno.

Automatic pop-waste, click-clack system, 1"1/4, big plug, with overflow.



905 SCC

Scarico automatico quadrato 1"1/4 con click-clack con troppo pieno.

Squared automatic pop-up waste 1"1/4 with click-clack system with overflow.



906 CC

Scarico automatico con sistema click-clack, 1"1/4, con troppo pieno.

Automatic pop-waste, click-clack system, 1"1/4, with overflow.



907

Scarico automatico 1"1/4 con tappo grande sempre aperto e sistema click-clack per la pulizia interna.

Automatic pop-up waste 1"1/4 with big plug always opened, and click-clack system for internal cleaning.

ACCESSORI PER RUBINETTERIA

cm 10x10



913 GVC 10

Copertura a pavimento in inox cm 10x10 , con griglia fissa e coperchio mobile.

Stainless steel floor drain cm 10x10, with fixed grill and movable plug.



913 GV 10

Copertura a pavimento in inox cm10x10, con griglia fissa.

Stainless steel floor drain cm 10x10, with fixed grill.

cm 15x15



913 GVC 15

Copertura a pavimento in inox cm 15x15 , con griglia fissa e coperchio mobile.

Stainless steel floor drain cm 15x15, with fixed grill and movable plug.



913 CV 15

Copertura a pavimento in inox cm15x15 , con coperchio avvitato fisso.

Stainless steel floor drain cm 15x15, with fixed cover.



913 GFC 15

Copertura a pavimento in inox cm 15x15 , con griglia e coperchio mobili.

Stainless steel floor drain cm 15x15, with movable grill and movable plug.



913 GV 15

Copertura a pavimento in inox cm 15x15, con griglia fissa.

Stainless steel floor drain cm 15x15, with fixed grill.

cm 20x20



913 GVC 20

Copertura a pavimento in inox cm 20x20 , con griglia fissa e coperchio mobile.

Stainless steel floor drain cm 20x20, with fixed grill and movable plug.



913 CV 20

Copertura a pavimento in inox cm 20x20, con coperchio avvitato fisso.

Stainless steel floor drain cm 20x20, with fixed cover.



913 GFC 20

Copertura a pavimento in inox cm 20x20 , con griglia e coperchio mobili.

Stainless steel floor drain cm 20x20, with movable grill and movable plug.



913 GV 20

Copertura a pavimento in inox cm 20x20, con griglia fissa.

Stainless steel floor drain cm 20x20, with fixed grill.

ANTI SCARAFAGGIO - ANTI COCKROACH-INSECTS



913 PSA 01

Sifone anti-scarafaggio da utilizzare per coperture a pavimento cm 15x15 e 20x20.

Anti cockroach-insects to use under the floor drains with size cm 15x15 e 20x20.



913 PSA 02

Sifone anti-scarafaggio da utilizzare per coperture a pavimento cm 10x10.

Anti cockroach-insects to use under the floor drains with size cm 10x10.

RETTANGOLARI - RECTANGULARS



913 RG 12

Canalina sifonata a pavimento, in inox, con griglia di drenaggio, larghezza 12,5 cm lunghezze cm 70, 80, 90, 100, 120.

Rectangular floor drain, in stainless steel, with drain grill, large 12.5 cm, lengths cm 70, 80, 90, 100, 120.



913 RP 12

Canalina sifonata a pavimento, in inox, piastrellabile, larghezza 12,5 cm lunghezze cm 70, 80, 90, 100, 120.

Rectangular floor drain, in stainless steel, model for tiling, large 12.5 cm, lengths cm 70, 80, 90, 100, 120.

PILETTE SIFONATE - SIPHON DRAINS



913 SF 10

Piletta da pavimento sifonata in inox, cm 10x10.

Stainless steel floor drain and siphon, cm 10x10 .



913 SF 15

Piletta da pavimento sifonata in inox, cm 15x15.

Stainless steel floor drain and siphon, cm 15x15.



913 SF 20

Piletta da pavimento sifonata in inox, cm 20x20.

Stainless steel floor drain and siphon, cm 20x20.

ACCESSORI PER RUBINETTERIA



977
Sifone a "P" in tubo, in ottone cromato, 1" 1/4".
"P" trap made by tube, in c.p. brass, 1" 1/4".



970
Sifone a bottiglia in ottone cromato, canotto cm 25, 1", 1" 1/4, 1" 1/2.
C.P. brass bottle trap, 25 cm outlet tube, 1", 1" 1/4, 1" 1/2.



971
Sifone a "S" in ottone cromato, canotto cm 25, 1", 1" 1/4.
C.P. brass "S" trap, 25 cm outlet tube, 1", 1" 1/4.



972
Sifone a "U" per lavabo a colonna in ottone cromato, canotto cm 25, 1", 1" 1/4.
C.P. brass "U" trap, 25 cm outlet tube, 1", 1" 1/4.

971 Z
Sifone a "S" in zama, canotto cm 25, 1", 1" 1/4.
"S" trap in zamac, 25 cm outlet tube, 1", 1" 1/4.



970 Z
Sifone a bottiglia in zama senza pilettina, per lavabo, 1" 1/4, 1" 1/2, canotto cm. 30.
Bottle trap in zamac without waste, for wash-basin, 1" 1/4, 1" 1/2, outlet tube cm 30.



973 Z
Sifone a bottiglia in zama con pilettina, per lavabo, 1" 1/4, 1" 1/2.
Bottle trap in zamac with waste, for wash-basin, 1" 1/4, 1" 1/2.



968
Ghiera per sifoni in ottone cromato, 1" M x 1" 1/4 F, 1" 1/4 M x 1" 1/2 F.
C.P. brass reduction for trap 1" M x 1" 1/4 F, 1" 1/4 M x 1" 1/2 F.



969
Ghiera per sifoni in ottone cromato, 1" 1/4 M x 1" F, 1" 1/2 M x 1" 1/4 F.
C.P. brass reduction for trap 1" 1/4 M x 1" F, 1" 1/2 M x 1" 1/4 F.



958 L

Sifone "MINIMAL" in ottone cromato, per lavabo, 1"1/4, canotto cm 30 e rosone pesante.

C.P. brass "MINIMAL" P trap, for wash-basin, 1"1/4, outlet tube cm 30 and heavy flange.



958 B

Sifone "MINIMAL" in ottone cromato, per bidet, 1"1/4, canotto cm 30 e rosone pesante.

C.P. brass "MINIMAL" P trap, for bidet, 1"1/4, outlet tube cm 30 and heavy flange.



960

Sifone SQ, in ottone cromato, canotto cm 30, 1"1/4, con rosone pesante quadrato in ottone cromato.

C.p. brass SQ trap, 30 cm outlet tube, 1"1/4, with heavy square wall flange.



965

Sifone esagonale in ottone cromato, 1"1/4, canotto cm 30 e rosone pesante.

C.p. brass hexagonal P trap, 1"1/4, outlet tube cm 30 and heavy flange.



956

Sifone fuso pesante lusso in ottone cromato, per lavabo e bidet 1", 1" 1/4 canotto cm 30.

C.P. brass luxury "P" trap, heavy type, 1", 1" 1/4, outlet tube cm 30.

ACCESSORI PER RUBINETTERIA



96

Colonna di scarico automatica con filo esterno e tubo in rame senza dado e codulo.

C.P. brass automatic bath waste and overflow with external wire and copper tube.



96 CC

Colonna di scarico con tubo in rame, con piletta "click-clack".

C.P. brass waste and overflow with copper tube and "click-clack" waste.



96 P

Colonna di scarico automatica in plastica con filo esterno, senza dado e codulo.

Plastic combined bath waste with automatic pop-up with external wire.

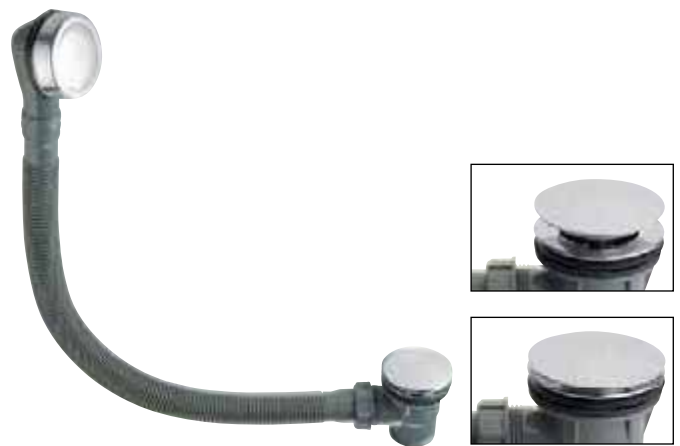

96 PCC

Colonna di scarico in plastica, con piletta "click-clack".

Plastic combined bath waste and overflow, "click-clack" waste system.



96 VA

Colonna di scarico automatico con filo esterno e tubo in rame cm 70, per vasca ad angolo.

C.P. brass automatic bath waste, overflow and copper tube, cm 70, for bath tube edge.



96 CC

Colonna di scarico con tubo in rame e piletta click-clack, tutta cromata.

Brass waste and overflow with copper tube and click clack waste, all chrome plated.

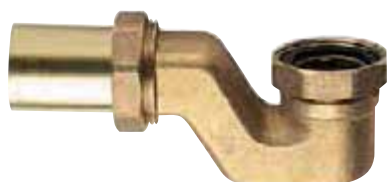

98

Sifone pesante in ottone fuso, con dado 1"1/2 per colonna vasca.

Heavy trap in casting brass, with nut 1"1/2 for bath waste and overflow.



CERTIFICATO

per il sistema di gestione secondo

EN ISO 9001:2008

La prova della conformità alla norma sopra indicata è stata fornita e viene documentata secondo le procedure TÜV PROFICERT per



REMER RUBINETTERIE s.p.a.
Via Leonardo da Vinci, 83
I - 20062 Cassano D'Adda (MI)

Campo di applicazione

**Progettazione, produzione e vendita di rubinetteria,
articoli per idraulica, accessori e complementi per bagno e cucina**

EA-Scopo 17/2

NO registrazione certificato 73 100 2281
Rapporto di Audit 4179 9154
Valido fino al 2014-03-24
Prima certificazione 2008-03-07



TGA-ZM-05-07-00



Darmstadt, 2011-03-25
Organismo di Certificazione del TÜV Hessen
- Responsabile della certificazione -

Pagina 1 / 1

Questa certificazione è stata eseguita secondo la procedura TÜV PROFICERT per verifiche e certificazioni e viene periodicamente sorvegliata.
Verificabile sul sito www.tuev-club.com. I certificati originali contengono un ologramma incollato.
TÜV Technische Überwachung Hessen GmbH, Rüdeshheimerstr. 119, D-64285 Darmstadt, Tel. +49 6151/600331



CERTIFICATO

per il sistema di gestione secondo
EN ISO 14001:2004

La prova della conformità alla norma sopra indicata è stata fornita e viene documentata secondo le procedure TÜV PROFICERT per



REMER RUBINETTERIE s.p.a.
Via Leonardo da Vinci, 83
I - 20062 Cassano D'Adda (MI)

Campo di applicazione

**Progettazione, produzione e vendita di rubinetteria,
articoli per idraulica, accessori e complementi per bagno e cucina**

EA-Scopo 17/2

№ registrazione certificato 73 104 2281
Rapporto di Audit 4179 9155
Valido fino al 2014-03-24
Prima certificazione 2008-03-07



TGA-ZM-05-07-60



Darmstadt, 2011-03-25
Organismo di Certificazione del TÜV Hessen
- Responsabile della certificazione -

Pagina 1 / 1

Questa certificazione è stata eseguita secondo la procedura TÜV PROFICERT per verifiche e certificazioni e viene periodicamente sorvegliata.
Verificabile sul sito www.tuev-club.com. I certificati originali contengono un ologramma incollato.
TÜV Technische Überwachung Hessen GmbH, Rüdeshheimerstr. 119, D-64285 Darmstadt, Tel. +49 6151/600331



CERTIFICATE

Management system as per

EN ISO 9001:2008

Evidence of conformity with the above standard(s) has been furnished
and is certified in accordance with TÜV PROFICERT procedures for



REMER RUBINETTERIE s.p.a.
Via Leonardo da Vinci, 83
I - 20062 Cassano D'Adda (MI)

scope

**Design, production and sale of taps and fittings, hydraulic items,
accessories and complements for bathroom and kitchen**

EA-Scope 17/2

Certificate registration No. 73 100 2281
Audit Report No. 4179 9154
Valid until 2014-03-24
First certification 2008-03-07



TGA-ZM-05-07-00



Darmstadt, 2011-03-25
Certification body of TÜV Hessen
- Head of Certification body -

Page 1 of 1.

This certification was conducted in accordance with the TÜV PROFICERT auditing and certification procedures and is subject to regular surveillance audits. Verifiable under www.tuev-club.de. Original certificates contain a glued on hologram.
TÜV Technische Überwachung Hessen GmbH, Rüdeshheimerstr. 119, D-64285 Darmstadt, Tel. +49 6151/600331



CERTIFICATE

Management system as per

EN ISO 14001:2004

Evidence of conformity with the above standard(s) has been furnished
and is certified in accordance with TÜV PROFICERT procedures for



REMER RUBINETTERIE s.p.a.
Via Leonardo da Vinci, 83
I - 20062 Cassano D'Adda (MI)

scope

**Design, production and sale of taps and fittings, hydraulic items,
accessories and complements for bathroom and kitchen**

EA-Scope 17/2

Certificate registration No. 73 104 2281
Audit Report No. 4179 9155
Valid until 2014-03-24
First certification 2008-03-07



TGA-ZM-05-07-60



Darmstadt, 2011-03-25
Certification body of TÜV Hessen
- Head of Certification body -

Page 1 of 1.

This certification was conducted in accordance with the TÜV PROFICERT auditing and certification procedures and is subject to regular surveillance audits. Verifiable under www.tuev-club.de. Original certificates contain a glued on hologram.
TÜV Technische Überwachung Hessen GmbH, Rüdeshheimerstr. 119, D-64285 Darmstadt, Tel. +49 6151/600331

SISTEMA[®]

